

Laguna®

SYSTEMY DO DRZWI PRZESUWNYCH

KATALOG CATALOGUE



polski producent

ISO 9001:2008

nr 1 W TECHNOLOGII
SYSTEMÓW
DRZWI PRZESUWNYCH
www.laguna.pl ISO 9001:2008
IN TECHNOLOGY OF SLIDING & FOLDING DOORS

nr 1 W TECHNOLOGII
SYSTEMÓW
DRZWI PRZESUWNYCH
www.laguna.pl ISO 9001:2008
IN TECHNOLOGY OF SLIDING & FOLDING DOORS

DLACZEGO WARTO BYĆ Z NAMI WHY IT'S GOOD TO BE WITH US

Tak jak w samochodzie sercem jest silnik, tak w systemach przesuwanych, podstawą są okucia jezdne i prowadniki. Krótko mówiąc okucia. Dlatego firma Laguna swoją ofertę opiera na produkcji okuć, produkcji tylko w Polsce. Od 2013 roku Laguna postawiła na promocję firmy jako Polskiej Fabryki Okuć. Na okuciach jezdnych opiera się cały ciężar drzwi. Wyroby w procesie produkcji są regularnie poddawane kontroli i testom zarówno na etapie przygotowywania jak i produkcji. Firma posiada własny dział projektowania i konstrukcji. Jest pierwszą firmą w branży okuć, która w roku 2000 otrzymała i nadal posiada certyfikat jakości ISO 9001. Ponadto firma posiada trzy europejskie patenty, 30 wzorów użytkowych oraz 45 wzorów przemysłowych. Laguna stale współpracuje z Instytutem Wzornictwa Przemysłowego.

Główne atuty naszych produktów

1. najwyższa jakość w technologii produktów od surowca do wykonania
2. długa żywotność okuć i profili
3. łatwość w montażu i eksploatacji
4. uniwersalność oferty - dwa, trzy wypełnienia w jednym profilu
5. nowoczesność - nikt przed nami, zawsze po nas
6. bezawaryjność działania- lekko, cicho, dokładnie
7. innowacyjność - odważne pomysły, najnowsze trendy, ciekawy design
8. różnorodność wzorów- od bryły kwadratowej do okrągłych i łukowych form
9. doświadczenie - 20 lat na rynku
10. bezpieczeństwo współpracy - brak reklamacji, gwarantowany zysk

Just as in a car, its heart is the engine, in sliding systems wheels and guides are the most important. That's why Laguna's offer is based on the production of hardware, only in Poland. In 2013 Laguna has decided to promote the fact it is The Polish Hardware Factory. Driving hardwares are the main elements responsible for the weight of the door. Products are regularly inspected and tested in the production process both the preparation and production level. The company has its own design and engineering department. In year 2000 Laguna was the first company in the hardware industry, which received the ISO 9001 quality certificate. What is more, the company has three European patents, 30 utility designs and 45 industrial designs. Laguna constantly cooperates with the Industrial Design Institute.

The main advantages of our products

1. the highest quality of product technology - from raw material to perform
2. long durability of fittings and profiles, 2 years warranty
3. easy installation and exploitation
4. offer universality - two, three fillings in one profile
5. modernity - no one is before us, we are always first
6. failure-free operation-light, quiet, precise
7. innovation - bold ideas, latest trends, interesting design
8. variety of designs, from solid square to round and curved forms
9. experience - 20 years on the market
10. security of cooperation - no complaints, guaranteed profit





Szanowni Państwo,

Oddajemy do rąk Państwa ponownie zmodyfikowany katalog produktów. Do kart podstawowych, dodaliśmy więcej zdjęć oraz informacji. Także poprawiliśmy układ prezentacji wyrobów do lewej strony. Dodaliśmy także czytelne ramki, wagi i opakowania, nowe indeksy i języki. Do ramek załączyliśmy zdjęcia oraz numery handlowe. Mamy nadzieję, że tak przedstawiony asortyment wraz z opisem, ułatwi Państwu składanie w przyszłości zamówień w szerszym zakresie

Żyjemy w czasie ciągłych przemian, nowych wyzwań i oczekiwań. Dziś już nikt nie może powiedzieć, że postawa konserwatywna i niechęć do zmian gwarantują sukces w biznesie. Wciąż trzeba ulepszać, poprawiać, dopasowywać się do rynku. Dlatego pracujemy nad ulepszeniem, innowacyjnością i oryginalnością. To nic, że za niedługi czas znajdziemy naśladowców. Wierzymy w magię pierwszeństwa. Przez 20 lat firma Laguna znacznie się rozwinęła. Z małej, garażowej produkcji przeobraziła się w przedsiębiorstwo z własnym zakładem produkcyjnym 4 tys. m kw. powierzchni pod dachem. O obrotach rocznych przeszło 80 mln zł oraz 100 pracownikami. W chwili obecnej firma stawia nowy zakład produkcyjny o powierzchni 8 tys. mkw hal produkcyjnych oraz 1000 m kw. pomieszczeń biurowych. To wszystko uzyskano dzięki ciągłemu rozwojowi w myśl filozofii japońskiej "krok po kroku, zawsze do przodu" Wszystkie inwestycje Laguna prowadzi z własnych, wcześniej odłożonych środków, bez kredytów.

Jesteśmy dumni z Państwa lojalności i przywiązania do naszych produktów i personelu, który Państwa firmy obsługuje z wielką radością. Poczucie bezpieczeństwa współpracy z Państwem jest dla nas główną nagrodą.

Ladies and Gentlemen,

We are giving you our latest, modified systems catalogue. Excepting well known primary systems cards, we added more photos and new information. We designed new layout to show you weight, packaging system, index numbers and the description of accessories. We hope it will make it easier for you to submit orders in a wider range in the future.

We live in a time of constant change, new challenges and expectations. Today no one can say that conservative attitude and unwillingness to change is a guarantee of success in business. We still need to improve, enhance and adapt to the market. That is why we are working on improvement, innovation and originality. No matter that in a short time we will find imitators. We believe in the magic of being pioneers. During our 20 year existence on the market, Laguna has greatly developed. From a small garage manufacture it has grown into a company with its own manufacturing plant 6.000 square meters under roof, the annual turnover over 100 million PLN and 100 employees. It's all thanks to continuous development we obtained in accordance with the Japanese philosophy "step by step, always forward", determination and perseverance, hard work, no bank loans and no support from outside institutions.

We are proud of your loyalty to our products and personnel. Cooperation with you gives us sense of security and that is the best possible award.

Dyrekcja Firmy Laguna
Thank You
Anna i Grzegorz Dolny





SZYBKIE I BEZPŁATNE WYMIAROWANIE KALKULATOR OBLICZENIOWY DIMENSIONING - QUICK & FREE OF CHARGE

Bezpłatna aplikacja, dzięki której w kilka chwil można obliczyć wymiary płyt, długości profili, ilości okuc i akcesoriów potrzebnych do zabudowy. Zapraszamy na stronę www.laguna.pl do skorzystania z zakładek: **KALKULATOR WYMIARÓW** oraz **INSTRUKCJE MONTAŻU**.

Free of charge on-line application for calculation of furnishing dimensions. You can get board dimensions, hardwares and accessories number quickly and easily.

Visit www.laguna.pl and try free:

DIMENSIONS CALCULATOR and **ASSEMBLING MANUALS**.

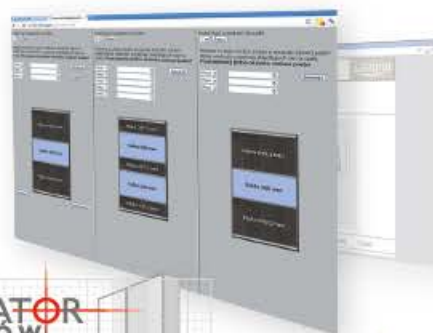

ŁATWE NAWIERCANIE OTWORÓW W PROFILACH EASY AND QUICK DRILLING IN VERTICAL PROFILES

3 formaty przyrządów do nawiercania otworów w profilach pionowych Rama, Interio, Multiomega, Gama i Multigama zwanych uchwytami-rączkami, pozwalające na ich szybkie i łatwe łączenie z ramiakami poziomymi.

3 different tools for quick marking and drilling in vertical profiles Rama, Interio, Multiomega, Gama and Multigama. There is no need to use pencils or rulers to connect profiles quickly.



DRUKI ZAMÓWIEŃ ORDER FORMS

Modyfikacji uległy także druki zamówień dostępne na stronie www.laguna.pl. Pierwsza cyfra numerycznego oznaczenia świadczy o przynależności okucia do grupy profili i torów. W systemach aluminiowych ostatnia cyfra mówi o kolorze anody.

Druki umożliwiają także wybór sposobu cięcia profili na odcinki A; B; C...J. Korzystanie z druków znacznie przyspiesza proces realizacji zamówienia.

Order forms available at www.laguna.pl have also been modified. First digit in number marks the hardware membership to particular group of profiles and rails. In aluminum systems, the last digit marks the profile color.

Order form enable you to determine the profile cutting on particular length from A do J. Using our order forms shortens the realization time significantly.





OPAKOWANIA PACKAGING

W 2012 wprowadzamy ujednolicony design opakowań do kompletów. Pudełka zostały wyposażone w eurozawieszkę oraz indywidualną etykietę informacyjną zabezpieczającą przed przypadkowym otwarciem. Sposób pakowania, zawartość kompletów i zestawów przedstawiamy w opisie każdego systemu.

In 2012 we unify our packaging desing. All boxes have an euro-slot and an individual label which protects the box content and informs about all elements inside. We present all systems packaging and logistic data in the description of each system.

EKSPOZYTORY WYSTAWKI ORAZ POTYKACZE EXPOSITIONS

Dla lepszej prezentacji oferty przygotowaliśmy nowy design wystawek prezentujących wyroby firmy Laguna. Ekspozytory dostępne są w kilku rozmiarach i opcjach: *wolnostojące-dwustronne, *wiszące i stawiane pod ścianą. Obok wystawek opracowaliśmy dla Państwa tekturowe, ładnie przygotowane potykacze informacyjne,

In order to present our offer in a clear way, we have created new design of systems' exhibitors. Our exhibitors are available in few sizes and options, they exhibit elements like profiles, hardwares, grips, profiles and types of connections. They also enable the increase of sale of less known accessories. Beside exhibitors we have designed cardboard information bollards.



NOWY DESIGN WZORNIKÓW PROFILI NEW DESIGN OF PROFILES SAMPLERS

Dużą pomocą w relacji dystrybutor-stolarz jest przygotowany przez Lagunę wzornik wybranych profili. Wzornik pozwala zorientować się kształtach, kolorach oraz podaje rodzaj i grubość wypełnienia. Wzornik profili można także zawiesić na ścianie.

Our profile samplers are very helpful in keeping good relations between the distributors and carpenters (clients). This portfolio of grip profiles and tracks shows the color, shape and thickness of filling materials. It is a handy briefcase that can be also hung on the wall.



JAK CZYTAĆ

cechy systemów

HOW TO READ features of the systems

FOTO REALIZACJI SYSTEMU
PHOTOGRAPHY
OF SYSTEM REALIZATION

FOTOGRAFIE ELEMENTÓW,
NAZWY, UMIEJSCOWIENIE
PHOTOGRAPHY
OF SYS. ELEMENTS
AND LOCATION

TYP ŁOŻYSKOWANIA
BEARING TYPE

MAX. WAGA SKRZYDŁA
MAX. WEIGHT
OF DOOR LEAF

SUSPEND 10

MAX. WAGA SKRZYDŁA: 40kg

WYSOKOŚĆ SKRZYDŁA: 4,6mm

GRUBOŚĆ SZYNY: 8, 10mm

RODZAJ WYPEŁNIENIA SKRZYDŁA: DOOR LEAF FILLING MATERIALS

RYS TECHNICZNY ZŁOŻENIOWY: TECHNICAL DRAWING OF SYS. ASSEMBLING

ELEMENTY SYSTEMU W KOMPLECIE: SYSTEM ELEMENTS IN SET

AKCESORIA OPCJONALNE: OPTIONAL ACCESSORIES

KOMPLET (DO 1 SZYNY)	WAGA (kg)	WYSOKOŚĆ (mm)	WAGA (kg)	WYSOKOŚĆ (mm)
1 SZYNA DO 1 SZYNY	11,71	8,0	10,0	10,0

OPCJE NABYCIA
I KOLORY PROFILI
BUYING OPTION
AND PROFILES COLORS

PROFILE, SZYNY,
TORY, RAMIAKI
PROFILES, RAILS,
TRACKS,
CONNECTING PROFILES

PROFILE PODSTAWOWE
BASIC PROFILES

SZYBKI DOSTĘP DO ROZDZIAŁÓW
POPURZEC 3 KOLORÓW REGISTROW
QUICK ACCESS WITH 3 COLORS
OF THE CATALOGUE CHAPTERS

BUDOWLANE CONSTRUCTION TYPES
MEBLOWE FURNITURE SYS
ZABUDOWY ALUMINIUM FURNISHING

systemy BUDOWLANE

construction type systems		PRZEWODNIK GUIDE	12-19
EKONOM	40kg		20
LIDER	50kg	drzwi przejściowe proste passage sliding doors	22
STANDARD	100kg		24
SYNCHRONIK	100kg	para drzwi rozsuwana synchronicznie two doors slided synchronously	26
PORTA GLASS	75kg	drzwi przejściowe szklane passage sliding glass-doors	28
PORTA GLASS SYNCHRONIK	75kg	para drzwi szklanych rozsuwanych synchronicznie two glass-doors slided synchronously	30
BIFOLD	20kg		32
EKOFOLD	40kg	drzwi składane folding door	34
STANFOLD	40 kg		36
SUSPEND 10 18mm	50kg	adaptacja systemów zabudów w drzwiach przejściowych adaptation of high furnishing sys. for passage door	38
GUSTAVSON	100kg	drzwi chowane w ścianę the door hidden in the wall	42

systemy MEBLOWE

furniture systems		PRZEWODNIK GUIDE	44-51
OPEN	35kg	drzwi uchylne side opened door	52
UNIFUTURE	15 30 50kg	drzwi mijane na jednej szynie overlap sliding door	54
UNIFUTURE GLASS	25kg	przesuwne drzwiczki szklane little glass-door	56
FUTURE	30 50kg	drzwi szaf z wbudowanym cokołem the wardrobes with build-in pilth	58
SIMPLE	30 50kg		60
TOP	60kg	nawierzchniowe drzwi szaf surface door of the wardrobes	62
OUTER	30 50kg		64
FAST FAST R	25 50kg	drzwi przesuwne szafek sliding door of the cabinets	66
FACTOR FACTOR R	60kg	drzwi zabudowy niskiej wysokiej the cabinets and wardrobes door	70
MINI CABINET		system przesuwny do ramek sliding system for frames	72

systemy ZABUDOWY ALUMINIOWE

aluminium furnishings		PRZEWODNIK GUIDE	74-83
HOUSE	60kg		84
EKO	40kg	drzwi przesuwne zabudowy lekkiej grubości 10mm low weight sliding door, 10mm thick	86
GAMA MULTIGAMA	50kg		88
DELTA	50kg		92
INTERO	50kg	drzwi do zabudowy 2-stronnej walk-in type of furnishing, 2-sided grip profiles	94
RAMA RAMA PLUS	50kg		96
OMEGA	50kg	drzwi przesuwne proste w zabudowach sliding door in high furnishing	100
MULTIOMEGA	50kg		102
SMART PRESTIGE	50kg	drzwi składane w zabudowach folding door in high furnishing	104
SLOPING		zabudowy przy skośnych ścianach i sufitach folding door for sloping walls & ceilings	106
AMS		aluminowe moduły systemowe aluminium modular system	108
EXPANDER		system prostujący płyty door panels straightening	110
INDEX			111

Bycie pionierami w branży systemów przesuwnych zobowiązuje. Dlatego postawiliśmy na ciągłe ulepszenia, zmiany i innowacje. Poniżej przedstawiamy kilka modyfikacji w produktach Laguna oraz nowości.

As pioneers in the field of sliding systems we feel obligated to certain things, that is why we are constantly improving, changing and being innovative. Beneath we proudly present modified Laguna products and some novelties.

FUTURE 30 / SIMPLE 30

Do zastosowania w systemach z serii Future 30 i Simple 30 proponujemy nową szynę AOF-030 i suwak ślizgowy AOU-030. Ich główne zalety to więcej przestrzeni i cichy przesuw. Suwak AOU-030 jest alternatywą dla prowadnika rolnego AOU-050, a szyna AOF-030 to zwężona wersja szyny dolnej AOF nr 3.

Our new proposition for systems Future 30 and Simple 30 is the rail AOF-030 and a slider AOU-030. Their main advantage is more space and a silent slide. The AOU-030 slider is an alternative for the wheel guide AOU-050, the rail AOF-030 is a narrower version of the lower rail AOF no. 3.



SLOPING

Wprowadzamy nową szynę anodowaną K-021 o wysokości 18mm, także w tym systemie użyć można suwaka AOU-030 zamiast prowadnika rolnego nr 8192. Atuty wynikające z tych zmian to większa przestrzenność oraz elegancja poprzez mocowania systemu na wysokości półki.

We introduce a new anodized rail K-021 of 18mm height that can be used with the slider AOU-030 instead of a wheel guide no. 8192. Owing to that we get more room and elegance because we can mount the system on an average shelf's height.



RĄCZKA MULTIOMEGA | GRIP MULTIOMEGA

Zmiana w konstrukcji profilu pionowego Multiomega. Ulepszenia wpłynęły na większą ergonomię i funkcjonalność rączki.

Nowe uszczelki U18 Multi nr 8700 oraz U18 Glass nr 8701. U18 Multi jest przeznaczona do stosowania w nowej Multiomedze, pozwala na osadzenie w profilu szyby o grubości 4mm. U18 Glass natomiast stosujemy w ramiaku i profilu łączącym.

Modifications in the construction of the horizontal profile Multiomega. Those improvements gave the grip more ergonomics and functionality.

New seal U18 Multi no. 8700 and U18 Glass no. 8701. U18 Multi is dedicated for using in the new Multiomega, it allows to put 4mm glass into the profile. Whereas, U18 Glass is used in our upper and lower connecting profiles.

MINI CABINET



Nowe okucia W-09 oraz W-10 pozwalają na zamocowanie szkła bez użycia profili aluminiowych, czyli wykonać front z tafli szklanej bez ramki.

New hardware W-09 and W-10 enables us to mount glass without using aluminum profiles that is make a glass front without the frame.



nr 0010
przewodnik
guide



nr 0009
okucie
hardware

KOLOR INOX | COLOR INOX



Nowy kolor anody,
w którym dostępne będą:

- Rączka Multiomega Brush
- Tor górny nr 8849
- Łącznik Domus nr 8189
- Tor dolny Gama nr 82099
- Profil łączący Rama nr 8879
- Ramiak Rama nr 8839
- ceownik C-18 nr 8669

New color of anodized aluminum,
products that will be available in this color:

- Grip Multiomega Brush
- Upper rail no. 8849
- Joint Domus no. 8189
- Lower rail Gama no. 82099
- Connecting profile no. 8879
- Upper/lower profile Rama no. 8839
- C-profile C-18 no. 8669



SYSTEMY BUDOWLANE CONSTRUCTION TYPE SYSTEMS



SYSTEMY BUDOWLANE CONSTRUCTION TYPE SYSTEMS











































Laguna[®]



nr 1 W TECHNOLOGII
SYSTEMÓW
DRZWI PRZESUWNYCH
www.laguna.pl ISO 9001:2008
IN TECHNOLOGY OF SLIDING & FOLDING DOORS

W TECHNOLOGII DRZWI PRZESUWNYCH I ZBIORNIKÓW
W TECHNOLOGII DRZWI PRZESUWNYCH I ZBIORNIKÓW
W TECHNOLOGII DRZWI PRZESUWNYCH I ZBIORNIKÓW
W TECHNOLOGII DRZWI PRZESUWNYCH I ZBIORNIKÓW

PRZEWODNIK SYSTEMÓW BUDOWLANYCH

	 EKONOM	 LIDER	 STANDARD	 SYNCHRONIK	 PORTA GLASS
PRZEZNACZENIE PURPOSE	do drzwi przejściowych prostych, bez progu for passage sliding doors no doorstep	do drzwi przejściowych prostych, bez progu for passage sliding doors no doorstep	do drzwi przejściowych prostych, bez progu for passage sliding doors no doorstep	do 2 skrzydeł drzwi bez progu rozsuwanych jednocześnie 2 sliding doors, no doorstep, synchronously opened	do drzwi szklanych przejściowych prostych, bez progu for sliding glass doors, no doorstep
MAX CIEŻAR DRZWI MAX DOOR WEIGHT	 40kg	 50kg	 100kg	 100kg	 75kg
WYPEŁNIENIA DRZWI DOOR LEAF FILLINGS	—  PLYTA BOARD 16 - 40 mm	—  PLYTA BOARD 18 - 40 mm	—  PLYTA BOARD 18 - 40 mm	—  PLYTA BOARD 18 - 40 mm	 SZKŁO GLASS 8 10 12 mm
SZYNA GÓRNA UPPER RAIL	K-075 nr/no 1 	K-075 nr/no 1 	K-075 nr/no 1 	K-075 nr/no 1 	K-075 nr/no 1 
OKUCIA HARDWARES	 POP-075 nr/no 1110	 MP-075/T nr/no 1178	 MP-100 nr/no 1120	 MP-100 nr/no 1120	 MP-G nr/no 1175 8mm 1176 10mm 1177 12mm
MASKOWNICA COVER RAIL	 I190	 I190	 I190	 I190	 I190
PROWADZENIE DOLNE LOWER GUIDANCE	 AO-075 nr/no 1150 biały white 1151 brąz brown	 AO-075 nr/no 1150 biały white 1151 brąz brown	 AO-075 nr/no 1150 biały white 1151 brąz brown	 AO-075 nr/no 1150 biały white 1151 brąz brown	 AOG nr/no 11010
STOPERY STOPPERS	 KP-075 nr/no 1140	 KPZ-075 nr/np 1141	 KPZ-075 nr/np 1141	 KPZ-075 nr/np 1141	 KPZ-075 nr/np 1141
SAMODOMYKACZ SOFT CLOSING	—	—	 nr/no 1673	—	 nr/no 1673
STRONA SEE PAGE	18	20	22	24	26

CONSTRUCTION TYPE SYSTEMS GUIDE

					
<p>PORTA GLASS SYNCHRONIK</p> <p>do 2 skrzydeł drzwi szklanych bez progu rozsuwanych jednocześnie 2 sliding glass doors, no doorstep, synchronously opened</p>	<p>BIFOLD</p> <p>do drzwi składanych, bez progu for folding doors, no doorstep</p>	<p>EKOFOLD</p> <p>do drzwi składanych, bez progu for folding doors, no doorstep</p>	<p>STANFOLD</p> <p>do drzwi składanych, bez progu for folding doors, no doorstep</p>	<p>SUSPEND</p> <p>adaptacja systemów zabudów aluminiowych dla drzwi przejściowych adaptation of high furnishing systems in passage doors</p>	<p>GUSTAVSON</p> <p>kasety do drzwi bezprogowych chowanych w ścianie aluminium cassette for doors hidden inside the wall, no doorstep</p>
<p> 75kg</p>	<p> 15kg</p>	<p> 20kg</p>	<p> 40kg</p>	<p> 50kg</p>	<p> 100kg</p>
<p> SZKŁO GLASS 8 10 12 mm</p>	<p>—</p>	<p>—</p>	<p>—</p>	<p> SZKŁO GLASS 4 6 mm</p>	<p> SZKŁO GLASS * 8 10 12 mm</p>
<p>—</p>	<p> PLYTA BOARD 16 - 40 mm</p>	<p> PLYTA BOARD 18 - 40 mm</p>	<p> PLYTA BOARD 18 - 40 mm</p>	<p> PLYTA BOARD 10 18 mm patrz see sys. GAMA, RAMA</p>	<p> PLYTA BOARD 18 - 40 mm</p>
<p> K-075 nr/no 1</p> <p> MP-G nr/no 1175 8mm 1176 10mm 1177 12mm</p>	<p> K-015 nr/no 3</p> <p> nr/no 903</p>	<p> K-075 nr/no 1</p> <p> PGP-075 nr/no 1110 with no906</p>	<p> K-075 nr/no 1</p> <p> MP-100 nr/no 1120 with no906</p>	<p> K-075 nr/no 1</p> <p> adapter 10mm nr/no 1182 adapter 18mm nr/no 1183</p>	<p> MP-100 nr/no 1120 *</p> <p> MP-G no 1175; 76; 77</p>
<p> 1190</p>	<p>—</p>	<p>—</p>	<p>—</p>	<p> 1190</p>	<p>—</p>
<p> AOG nr/no 11010</p>	<p> nr/no 902</p> <p> nr/no 906</p>	<p> nr/no 902</p> <p> nr/no 906</p>	<p> nr/no 902</p> <p> nr/no 906</p>	<p> nr 1154 przewodnik guide</p> <p> nr 1153 przewodnik guide</p>	<p> AO-075 nr/no 1150 biały white 1151 brąz brown *</p> <p> AOG nr/no 11010</p>
<p> KPZ-075 nr/np 1141</p>	<p> nr/no 900 amortyzator shock absorber</p>	<p> KP-075 nr/no 1140</p>	<p> KPZ-075 nr/np 1141</p>	<p> KPZ-075 nr/np 1141</p>	<p> KPZ-075 nr/np 1141</p>
<p> nr/no 1673</p>	<p>—</p>	<p>—</p>	<p>—</p>	<p> nr/no 1673</p>	<p>—</p>
<p>28</p>	<p>30</p>	<p>32</p>	<p>34</p>	<p>36</p>	<p>40</p>

typy systemów budowlanych

systems types

- do drzwi wykończonych profilami aluminiowymi
- chowanych w ścianę pojedynczych i podwójnych
- otwieranych jednocześnie - 2 skrzydła
- składanych - 2 i 4 skrzydła
- * do drzwi bezprogowych przejściowych:
- prostych - pojedynczych i podwójnych

- with decorative and finishing alu profiles
- door-cassette hidden in the wall
- synchronously opening 2 doors
- folding doors - 2 and 4 leaves no doorstep, passage doors:
- single and double door leaves

zastosowanie

application

- wszelkie przejścia pomiędzy pomieszczeniami
- biura i miejsca użyteczności publicznej
- przedpokoje, poddasza
- kuchnie, jadalnie, łazienki
- sypialnie i garderoby
- salony, pokoje gościnne

- offices and public spaces
- bathrooms, halls and attics
- kitchens and dining rooms
- bedrooms and changing rooms
- passage between rooms
- living rooms

rodzaje i grubości wypełnień

materials types & thickness



szkło, lustro, witraże | glass, mirror, stained glass

8 mm, 10 mm, 12mm



lekkie płyty (bambus, ratan, plexi)

light weight panels (bamboo, ratta, plexi)



płyty meblowe (MDF, HDF, wiórowa)

furniture boards (MDF, HDF, chipboard)



gotowe fronty drzwi bezfelcowych

ready to use, no-rabbit door



płyty z uchwytami pionowymi (z dwustronnymi rączkami) i przewiązkami

boards with vertical grip-profiles and connecting horizontal profiles



gotowe fronty drzwi bezfelcowych

ready to use, no-rabbit door

16 - 40mm

udźwig na 1 skrzydło drzwi

capacity for one door leaf

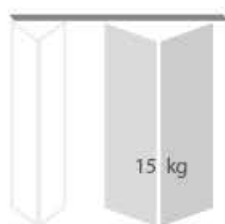

15 kg

Bifold

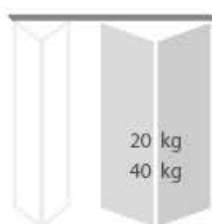

20 kg
40 kg

Ekofold
Stanfold



40 kg

Ekonom



50 kg

Lider
Suspend



75 kg

Porta Glass



100 kg

Standard
Gustavson



zalety i korzyści dla kupującego

advantages & benefits for buyer

- łatwe i szybkie w montażu maksymalnie 10 minut
- bez progowe
- długa żywotność okuć
- uniwersalna szyna
- easy & quick assembly, max. 10min.
- perfect for narrow interiors, takes only 7,5cm of space
- no doorstep
- long durability
- one universal rail - fitting different systems

PROWADZENIE GÓRNE I MASKOWNICA UPPER RAILS & COVERS



K-075 nr/no 1



K-076 nr/no 13



nr/no 1190



K-015 nr/no 9

Wyróżnikiem systemów budowlanych jest szyna aluminiowa o symbolu K-075 i numerze handlowym nr 1. Od gęstości zastosowania zamocowań szyny zależy montaż drzwi o różnym udźwigu. Im gęściej rozmieszczone są uchwyty, tym większy można zastosować udźwig drzwi. Obok szyny aluminiowej występuje także szyna stalowa o symbolu K-076 i numerze handlowym 13. Szyny stalowe są cięższe i trwalsze od aluminium, wadą jest, iż słychać w nich pracę okuć. Polecane najczęściej do obiektów przemysłowych. Szyny aluminiowe i stalowe sprzedawane są w odcinkach od 1,5 mb do 6,0 mb. Za pomocą specjalnego łącznika o symbolu LKU i numerze handlowym 1133 istnieje możliwość osiągnięcia dłuższych odcinków niż 6,0 mb. W celach estetycznych, firma opracowała maskownicę wykonaną z naturalnego, anodowanego aluminium. Uchwyty mocujące maskownicę do szyny wykonano z tworzywa. W ofercie posiadamy także specjalny uchwyt do mocowania dowolnej maskownicy np. z drewna.

The main element of building systems is the rail with the symbol K-075 and catalogue no. 1. The more fastenings used for rail mounting, the larger door weight can be suspended on a rail. Additionally, we offer a steel rail with symbol K-076 and no.13. Steel rails are heavier and more durable than aluminum, but the fitting works louder. That's why we recommend it mostly for industrial facilities. Aluminum and steel rails are sold in lengths from 1.5 m to 6.0 linear meters. Using a special connector with the LKU symbol and the trade number 1133 it is possible to achieve a rail longer than 6 linear meters.

For finishing and decorative purposes, the company has developed a mask made of natural anodized aluminum. The handles mounting the masks are made of plastic. Our offer also includes a special grip to attach any chosen mask, i.e. wooden.

UCHWYTY SZYNY GÓRNE J UPPER RAILS FASTENINGS



SKU-075 nr/no 1131



SKL-075 nr/no 1134



KK-075 nr/no 1132



LKU-075 nr/no 1133

Omówione powyżej szyny wymagają różnego sposobu mocowania zależnie od tego, czy mamy do czynienia z rozwiązaniem na ścianie, czy w nadprożu przejścia. W ofercie firma posiada także uchwyty z dystansem do ściany, sufitu oraz łączniki toru. Wszystkie uchwyty wykonane są ze stali ocynkowanej (warstwa cynku 5-8 μ). Możliwy zakres grubości płyt wynosi od 18mm do 40 mm. Polecamy montaż 4 sztuk uchwyty na każde 1,5 mb długości szyny.

There are different rail fixing methods depending on the place in which we apply the system - on the wall or on the ceiling. The company also offers fittings with the distance to the wall, ceiling- and door- fittings. All handles are made of galvanized steel (zinc layer 5-8 μ). Possible range of thicknesses of the door is from 18mm to 40 mm. We recommend mounting fittings 4 pieces for each 1.5 m long of the rail.

OKUCIA HARDWARES



POP-075 nr/no 1110



MP-100 nr/no 1120



MPF nr/no 1179



MP-075/T nr/no 1178



MP-G nr/no 1175,-76,-77



Pin nr/no 901



Pin nr/no 903

Okucia jezdne oferowane są ze zmienną ilością obracanych kółek i rodzajów łożysk, od których zależy maksymalny udźwig drzwi. Łożyska igiełkowe osadzone w korpusie z tworzywa oferowane są do drzwi o ciężarze do 50kg. Natomiast łożyska kulkowe podwójne przeznaczone są do udźwigu drzwi 40kg, a okucia czterokołkowe w korpusie metalowym do udźwigu 100 kg na jedno skrzydło. Interesującym rozwiązaniem jest okucie do szkła PORTA GLASD o grubości 8,10 i 12mm ze specjalną łapą - mocowaniem wykonanym z aluminium i pasków z korka.

Driving hardware are offered with a variable number of turning wheels, they determine the maximum door leaf capacity. Hardware with needle bearings in the body of plastic are available for doors weighing up to 50kg. 2-wheel ball bearing hardware are designed for lifting 40kg doors, and 4-wheel ball bearing metal hardware are made to lift 100 kg per one door leaf. A hardware for glass of thickness 8, 10 and 12 mm with a special glass grip - made of aluminum and strips of cork is a very interesting solution. There is no need to drill in the glass.

MOCOWANIA OKUĆ DO PŁYT BOARD PANEL FASTENING



PBP-075
nr/no 1111



PB-075
nr/no 1121



PBB-075
nr/no 1180



do/for
POP-075 i MPF

Posiadamy w sprzedaży zamocowania do płyt, z montażem od góry oraz z boku płyty - wpuszczane w wyfrezowany otwór Ø 35mm. Zamocowania do okuć wykonano ze stali ocynkowanej grubości (ocynk 5-8µ).

We sell the board fastenings that can be assembled from the top and on the side of the panels - in the mill cut Ø 35mm.

Fastenings are made of galvanized steel (zinc 5-8µ).

SAMODOMYKACZE I STOPERY SOFTCLOSING UNITS AND STOPPERS



Soft closing
nr/no 1673



KP-075
nr/no 1140



KPZ-075
nr/no 1141

Stopery zostały zaprojektowane dla szyny K-075 i K-076. Stopery wykonane są ze stali, specjalnej gumy i tworzywa. Akcesoria te wpływają dodatnio na komfort używania systemu - zapobiegają gwałtownym uderzeniom skrzydeł drzwi w ścianę.

Stoppers and soft-closer are designed for rails K-075 and K-076. They are made of steel, rubber and plastic. These accessories increase the comfort of using the system - softly slowing down the door and preventing an uncontrolled hit to the wall.

PROWADZENIE DOLNE SOFTCLOSING UNITS AND STOPPERS



AO-075
nr/no 1150



AOG
nr/no 1101



C-10
nr/no 6



Bifold pin
nr/no 902

Bifold seat
nr/no 906

Prowadzenie dolne służy do stabilizacji drzwi w pionie. Za pomocą prowadników z tworzywa, można objąć skrzydło drzwi lub wpisać prowadnik w wyfrezowany otwór w płycie lub w podłodze. Prowadniki dostępne są w dwóch kolorach: białym i brązowym. Do prowadzenia dolnego można użyć także aluminiowego ceownika o symbolu C-10 i numerze handlowym nr 6

Bottom guidance is used mainly to stabilize of the door in the vertical position. Using plastic guides enables you to take door leaves between two guides or put the guide in the mill cut in in the door bottom, you can put it in the floor as well. They are in two colors: white and brown. You can also use an aluminum channel section of the symbol C-10 and catalogue no.6. For glass door we have the aluminum guide of 4cm length, equipped with an inner transparent insert, it is adjustable depending on the thickness of the used glass.

ZAWIASY, BLOKADY, AKCESORIA HINGES, BLOCADES, ACCESSORIES



mosiądz | brass (M)
nr/no 1142
chrom | chrome (C)
nr/no 1143



mosiądz | brass (M)
nr/no 1176
chrom | chrome (C)
nr/no 1177

nr/no 900



nr/no 1174



Zawiasy wykonane zostały ze stali ocynkowanej w kolorach chrom i mosiądz. Dostępne w dwóch opcjach uniwersalnej i klasycznej. Obok tradycyjnych zawiasów firma posiada w sprzedaży zawiasy zatraskowe LUX utrzymujące skrzydła w jednej linii. Blokada ustawcza o numerze 1174 także wpływa na ustalenie pozycji drzwi po zamknięciu. Stosowana wyłącznie przy 4 skrzydłach.

The elements are made of galvanized steel in chrome and brass color. There is a universal hinge for traditional use in folding doors and blocking hinge LUX 1176/7 that keeps folding doors together after closing. Positioning lock 1174 also affects the fixed position of the door when closed.

Shock absorber prevents the door leaf from hits during their folding.

SUSPEND

Na specjalne życzenie klientów opracowaliśmy okucia do montażu złożonych systemów aluminiowych jako alternatywy dla bezprogowych drzwi przejściowych. Oznacza to, że elementy okuć zastosowano z systemów budowlanych, do których zaprojektowane adaptory, które łączą płytę z przewiązką aluminiową. Dzięki temu można zbudować skrzydło z wieloma szprosami oraz łączyć w nich wiele rodzajów materiałów i wypełnień. Adaptory wykonane są ze stali ocynkowanej i dostosowane do rozwiązań dla paneli 10mm oraz 18mm. Suspend pozwala na adaptację systemów Gama, Rama z wykorzystaniem dwustronnych rączek.



We have developed special hardware for assembly of complex aluminium systems as doorstep-free passage doors. This means that the building type of guidance is used and owing to special adaptors you can connect the aluminum sash with the board. This allows you to build a door leaf with many muntins and combine many types of filling materials in one door. Adaptors are made of galvanized steel and designed for 10mm and 18mm door panels. Suspend is a doorstep-free adaptation of Gama and Rama type systems in which we use two-sided handles.

SYNCHRONIK - linka kewlarowa | kevlar cord

Koło i naciąg linki wykonane są z tworzywa. Kewlarowa linka ma długość 8.0 mb, co oznacza, że szerokość jednego skrzydła drzwi może wynieść od 60cm do 1m max. System Synchronik sprzedawany jest w kompletach.



Synchronic is a system of 2 door leaves that open simultaneously. Circle and tension of the cord in this system are made of plastic. The cord is made of Kevlar and has a length of 8.0 m, which means that the width of the door leaf can vary from 60cm to a maximum of 1m. Synchronic system is sold in sets.

GUSTAVSON

Kaseta posiada oddzielnie zaprojektowaną szynę aluminiową ze specjalnym wycięciem od spodu i z miejscem do montażu okuć oraz stoperów z systemu Standard. Komplet Gustavson oferujemy do typowych drzwi bezprzylgowych o szerokości od 60 do 100 cm. System został opracowany do umieszczenia go wewnątrz ścian o grubości 100mm i 125mm. Całkowita wysokość kasety wynosi 2180 mm, szerokość 2060 mm. Kasety wykonane są z aluminium oraz stalowych listew bocznych. Futryny do kasety można nabyć do drzwi pojedynczych lub podwójnych. Dostępne kolory futryn, biała do malowania oraz bukowa oklejana naturalnym fornirem -nadaje się wybarwienia, nie jest lakierowana.



The Cassette has a separately designed aluminum rail with a special cut from the bottom and space for installation of fittings and stoppers from the Standard system. The Gustavson set is dedicated for non-rebated door of width from 60 to 100 cm. The system was designed to be placed inside the walls of 100mm and 125mm thickness. The total height of the cassette is 2180 mm and width 2060 mm.

Gustavson cassettes are made of aluminum and steel side bars. Frame of the door can be purchased optional for single or double door. Available colors of frames: white that can be painted and beech wood veneer that can be dyed because it has no lacquer surface.

SZCZOTKI BRUSHES

W drzwiach przejściowych budowlanych można zamontować szczotki odbojowe i przeciwkurzowe na wysokości i szerokości skrzydła. Szczotki dostępne są w rolach pakowanych po 100 i 150 mb.



Anti- impact and anti-dust brushes can be used in the height or width of the door leaf. Brushes are available in rolls packed with 150 mb.

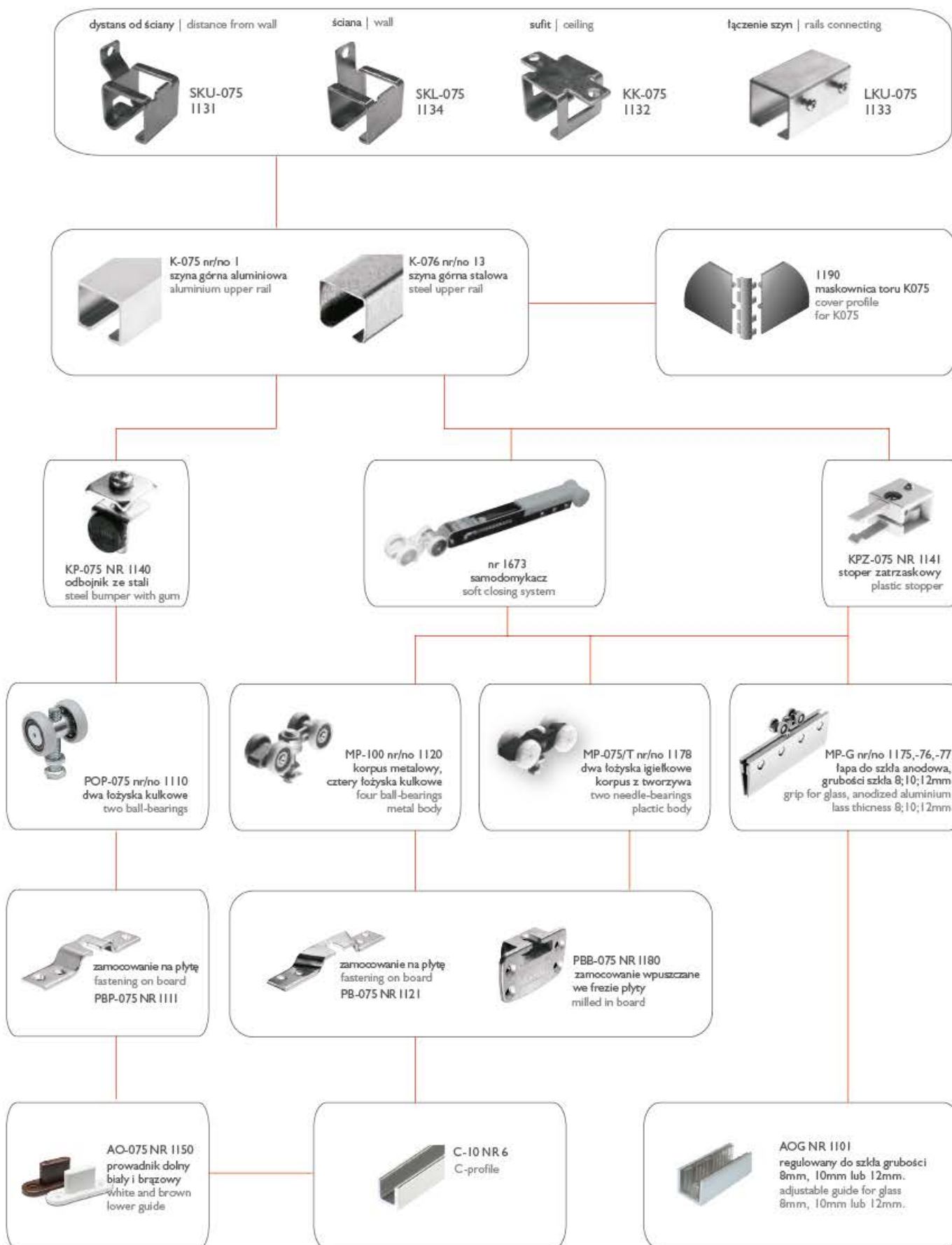





nr 1190
maskownica anodowana
anodized cover rail



nr 1134 SKL-075
uchwyty z dystansem do ściany
wall fastening with distance



nr 1 K-075
szyna górna
upper rail



nr 1140 KP-075
stoper / odbójnik
door stopper



nr 1110 POP-075
okucie budowlane EKONOM
hardware EKONOM



nr 1111 PBP-075
mocowanie do płyty
fastening to board



nr 6 C-10
ceownik
c-profile



nr 1150 AO-075 (biały | white)
nr 1151 AO-075 (brąz | brown)
prowadnik
guide



KOMPLET OKUĆ SET	NR KPL SET NO.	WAGA WEIGHT	ILOŚĆ KPL W KARTONIE NO. OF SETS IN BOX	WAGA KARTONU CARTON WEIGHT	UDŹWIG DO 40 KG CAPACITY UP TO 40 KG
1 SKRZYDŁO 1 DOOR LEAF	1160	0,26 kg	48 kpl / box	12,92 kg	1
2 SKRZYDŁA 2 DOOR LEAVES	1161	0,44 kg	48 kpl / box	21,35 kg	2
ZESTAW KIT DOSTĘPNE ZESTAWY AVAILABLE KITS					
KOMPLET OKUĆ + SZYNA (m.b.)	HARDWARE KIT + RAIL (meters)	1,5 m 2 m 2,5 m 3 m			

KOMPLET / SET zawartość pudełka / box content		
EKONOM	1	2
nr 1110	2	4
nr 1111	2	4
nr 1140	2	2
nr 1150	2	4



mocowanie maskownicy aluminiowej
assembling of aluminium cover

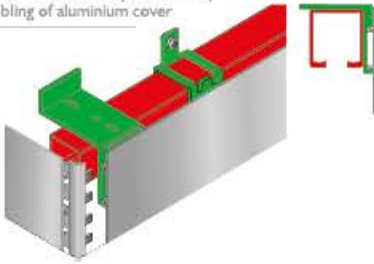

mocowanie maskownicy drewnianej
assembling of wooden cover

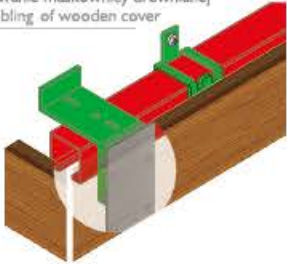

uchwyty | fastenings

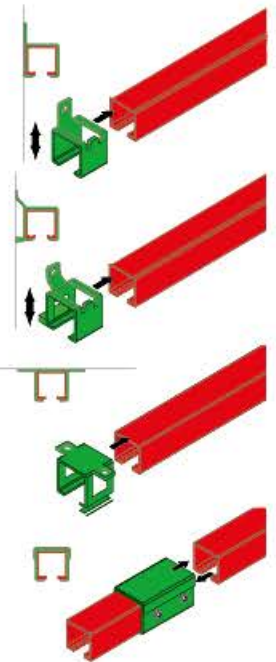

przewodniki | guides

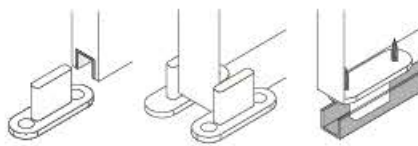

Szczegółowa instrukcja montażu
Detailed assembly manual
www.laguna.pl

SZYNY I PROFILE
RAILS AND PROFILES

aluminium długość max 6m
length max 6m



nr 1 K-075
szyna górna
upper rail

aluminium długość max 6m
length max 6m



nr 1190
maskownica anodowana
anodized cover rail

stal | steel długość max 4m
length max 4m



nr 13 K-076
szyna górna
upper rail

aluminium długość max 6m
length max 6m



nr 6 C-10
ceownik
c-profile

KOMPLET NA 1 SKRZYDŁO | DOOR LEAF SET



x2

nr 1110 POP-075
okucie budowlane EKONOM
hardware EKONOM

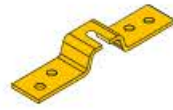

x2

nr 1111 PBP-075
mocowanie do płyty
fastening to board

x12



komplet wkrętów
screws set



x2

nr 1140 KP-075
stoper / odbajnik
door stopper

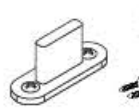

x2

nr 1150 AO-075
przewodnik biały
white guide

ELEMENTY MASKOWNICY

cover rail corner and holders



tworzywo
plastic

nr 1191
uchwyt sufitowy
fastening for ceiling

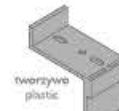

tworzywo
plastic

nr 1192
uchwyt ścienny
fastening for wall



tworzywo
plastic

RT8 nr 1193
narożnik z tworzywa
plastic corner



aluminium

nr 1194
mocowanie maskownicy
drewnianej
wooden cover fastening

UCHWYTY DO SZYNY K075/76 | K075/76 RAIL FITTINGS

montaż co 30cm | 30cm mounting distances



nr 1131 SKU-075
uchwyt do ściany
rail holder (to wall)



nr 1132 KK-075
uchwyt do sufitu
rail holder (to ceiling)



nr 1134 SKL-075
uchwyt z dystansem do ściany
wall fastening with distance



nr 1133 LKU-075
łącznik szyn
rails connector

ELEMENTY ZAMIENNI | INTERCHANGEABLE ELEMENTS



nr 1151 AO-075
przewodnik brązowy
brown guide



nr 1190
maskownica anodowana
anodized cover rail



nr 1134 SKL-075
uchwyt z dystansem do ściany
wall fastening with distance



nr 1 K-075
szyna górna
upper rail



nr 1141 KPZ-075
stoper zatraskowy
door stopper



nr 1178 MP-075/T
okucie budowlane LIDER
hardware LIDER



nr 1121 PB-075
mocowanie do płyty
fastening to board



nr 6 C-10
ceownik
c-profile



nr 1150 AO-075 (biały | white)
nr 1151 AO-075 (brąz | brown)
przewodnik
guide



KOMPLET OKUĆ SET	NR KPL SET NO.	WAGA WEIGHT	ILOŚĆ KPL W KARTONIE NO. OF SETS IN BOX	WAGA KARTONU CARTON WEIGHT	UDŹWIG DO 50 KG CAPACITY UP TO 50 KG
1 SKRZYDŁO 1 DOOR LEAF	1061	0,28 kg	48 kpl / box	13,72 kg	1
2 SKRZYDŁA 2 DOOR LEAVES	1062	0,48 kg	48 kpl / box	23,47 kg	2
ZESTAW KIT	DOSTĘPNE ZESTAWY AVAILABLE KITS				
KOMPLET OKUĆ + SZYNA (m.b.)	HARDWARE KIT + RAIL (meters)		1,5 m 2 m 2,5 m 3 m		

KOMPLET / SET zawiera 6 pudełek / box content

LIDER	1 nr 1061	2 nr 1062
nr 1178	2	4
nr 1121	2	4
nr 1141	2	2
nr 1150	2	4



ŁOŻYSKO IGIEŁKOWE
NEEDLE BEARING



50kg



18-40mm

mocowanie maskownicy aluminiowej
assembling of aluminium cover

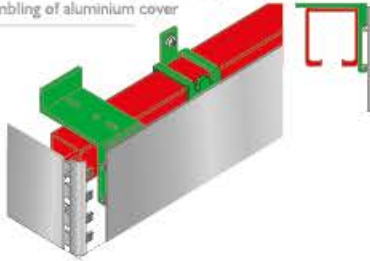

mocowanie maskownicy drewnianej
assembling of wooden cover

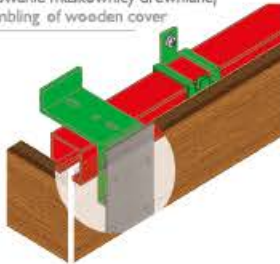

uchwyty | fastenings

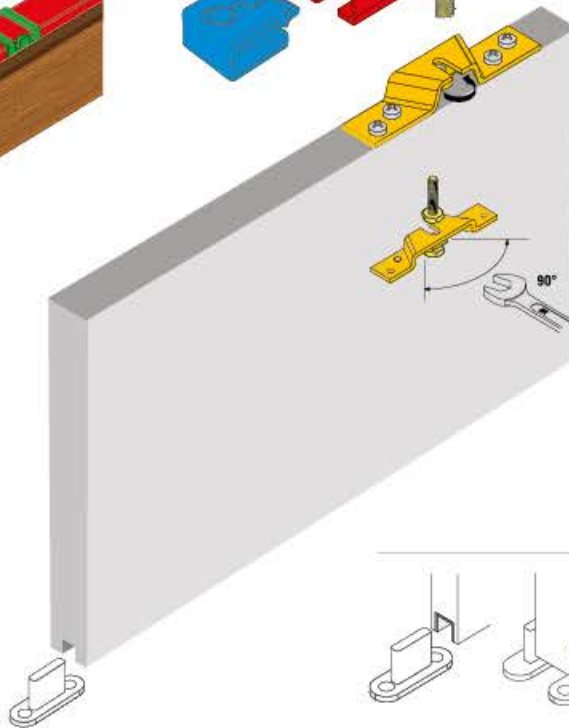
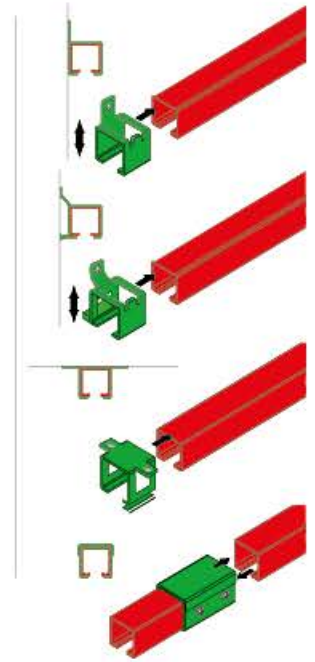

przewodniki | guides

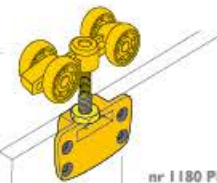
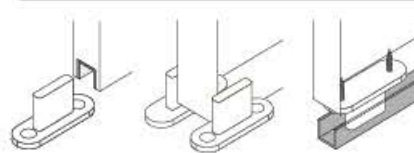

nr 1180 PBB-075
zamocowanie boczne
wpuszczane w płytę
side fastening

Szczegółowa instrukcja montażu
Detailed assembly manual
www.laguna.pl

SZYNY I PROFILE
RAILS AND PROFILES

aluminium długość max 6m
length max 6m



nr 1 K-075
szyna górna
upper rail

aluminium długość max 6m
length max 6m



nr 1190
maskownica anodowana
anodized cover rail

stal | steel długość max 4m
length max 4m



nr 13 K-076
szyna górna
upper rail

aluminium długość max 6m
length max 6m



nr 6 C-10
ceownik
c-profile

KOMPLET NA 1 SKRZYDŁO | DOOR LEAF SET

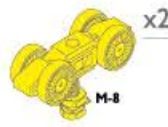

nr 1178 MP-075/T
okucie budowlane LIDER
hardware LIDER



nr 1121 PB-075
mocowanie do płyty
fastening to board



komplet wkrętów
screws set



nr 1141 KPZ-075
stoper zatraskowy
door stopper

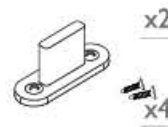

nr 1150 AO-075
przewodnik biały
white guide

ELEMENTY MASKOWNICY

cover rail corner and holders



nr 1191
uchwyt sufitowy
fastening for ceiling



nr 1192
uchwyt ścienny
fastening for wall



nr 1193 RT8
narożnik z tworzywa
plastic corner



nr 1194
mocowanie maskownicy
drewnianej
wooden cover fastening

UCHWYTY DO SZYNY K075/76 | K075/76 RAIL FITTINGS

montaż co 30cm | 30cm mounting distances



nr 1131 SKU-075
uchwyt do ściany
rail holder (to wall)



nr 1132 KK-075
uchwyt do sufitu
rail holder (to ceiling)



nr 1134 SKL-075
uchwyt z dystansem do ściany
wall fastening with distance



nr 1133 LKU-075
łącznik szyn
rails connector

ELEMENTY OPCJONALNE

OPTIONAL ELEMENTS



nr 1180 PBB-075
zamocowanie boczne
wpuszczane w płytę
side fastening

ELEMENTY ZAMIENNI

INTERCHANGEABLE ELEMENTS

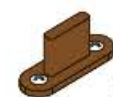

nr 1151 AO-075
przewodnik brązowy
brown guide



nr 1190
maskownica anodowana
anodized cover rail



nr 1134 SKL-075
uchwyt z dystansem do ściany
wall fastening with distance



nr 1 K-075
szyna górna
upper rail



nr 1680
samodomykacz STANDARD
soft closing STANDARD



nr 1141 KPZ-075
stoper zatrzaskowy
door stopper



nr 1120 MP-100
okucie budowlane STANDARD
hardware STANDARD



nr 1180 PBB-075
mocowanie boczne do płyt
side assembling for hardware



nr 6 C-10
ceownik
c-profile



nr 1150 AO-075 (biały | white)
nr 1151 AO-075 (brąz | brown)
prowadnik
guide



KOMPLET OKUĆ SET	NR KPL SET NO.	WAGA WEIGHT	ILOŚĆ KPL W KARTONIE NO. OF SETS IN BOX	WAGA KARTONU CARTON WEIGHT	UDŹWIG DO 100 KG CAPACITY UP TO 100 KG
1 SKRZYDŁO 1 DOOR LEAF	1162	0,38 kg	48 kpl / box	18,76 kg	1
2 SKRZYDŁA 2 DOOR LEAVES	1163	0,70 kg	48 kpl / box	33,98 kg	2
ZESTAW KIT	DOSTĘPNE ZESTAWY AVAILABLE KITS				
KOMPLET OKUĆ + SZYNA (m.b.)	HARDWARE KIT + RAIL (meters)	1,5 m	2 m	2,5 m	

KOMPLET / SET zawartość pudełka / box content

STANDARD	1 nr 1162	2 nr 1163
nr 1120	2	4
nr 1121	2	4
nr 1141	2	2
nr 1150	2	4



mocowanie maskownicy aluminiowej
assembling of aluminium cover

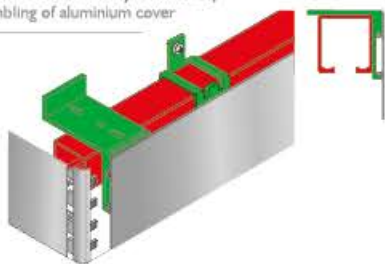

mocowanie maskownicy drewnianej
assembling of wooden cover

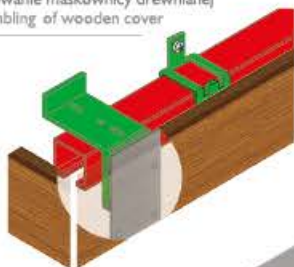

uchwyty | fastenings

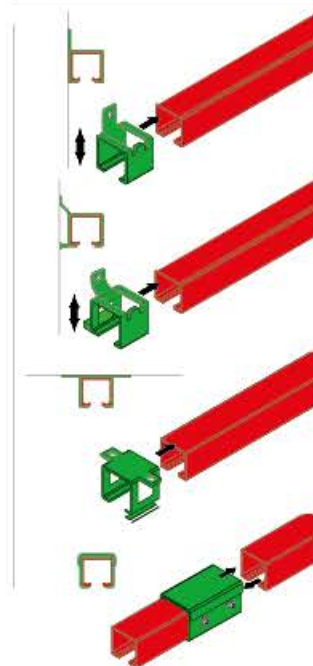

Szczegółowa instrukcja montażu
Detailed assembly manual
www.laguna.pl

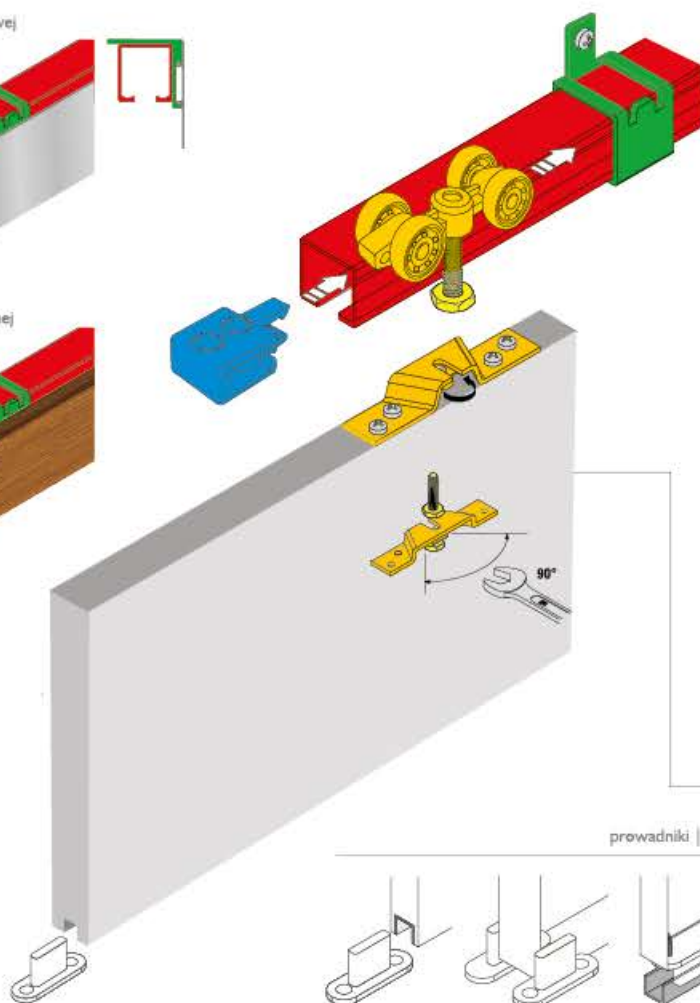

przewodniki | guides

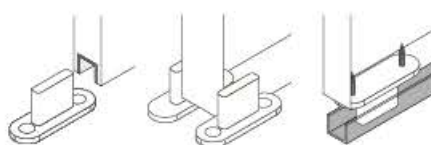

nr 1180 PBB-075
zamocowanie boczne
wpuszczane w płytę
side fastening

SZYNY I PROFILE
RAILS AND PROFILES

aluminium

dlugość max 6m
length max 6m



nr 1 K-075
szyna górna
upper rail

aluminium

dlugość max 6m
length max 6m



nr 1190
maskownica anodowana
anodized cover rail

stal | steel

dlugość max 4m
length max 4m



nr 13 K-076
szyna górna
upper rail

aluminium

dlugość max 6m
length max 6m



nr 6 C-10
ceownik
c-profile

KOMPLET NA 1 SKRZYDŁO | DOOR LEAF SET



nr 1120 MP-100
okucie budowlane STANDARD
hardware STANDARD



nr 1121 PB-075
zamocowanie do płyty
fastening to board



wkręty
screws



nr 1141 KPZ-075
stoper zatraskawowy
door stopper

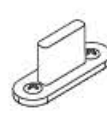

nr 1150 AO-075
przewodnik biały
white guide

ELEMENTY MASKOWNICY
cover rail corner and holders



nr 1191
uchwyt sufitowy
fastening for ceiling



nr 1192
uchwyt ścienny
fastening for wall



nr 1193 RTB
narożnik z tworzywa
plastic corner



nr 1194
mocowanie maskownicy
drewnianej
wooden cover fastening

UCHWYTY DO SZYNY K075/76 | K075/76 RAIL FITTINGS

montaż co 30cm | 30cm mounting distances



nr 1131 SKU-075
uchwyt do ściany
rail holder (to wall)



nr 1132 KK-075
uchwyt do sufitu
rail holder (to ceiling)



nr 1134 SKL-075
uchwyt z dystansem do ściany
wall fastening with distance



nr 1133 LKU-075
łącznik szyn
rails connector

ELEMENTY OPCJONALNE | OPTIONAL ELEMENTS



nr 1180 PBB-075
zamocowanie boczne
wpuszczane w płytę
side fastening

SAMODOMYKACZ | SOFTCLOSER



nr 1680
samodomykacz STANDARD | soft closing STANDARD 50kg

ELEMENTY ZAMIENNI
INTERCHANGEABLE ELEMENTS



AO-075 nr 1151
przewodnik brązowy
brown guide



nr 1190
maskownica anodowana
anodized cover rail



nr 1134 SKL-075
uchwyt z dystansem do ściany
wall fastening with distance



nr 1 K-075
szyna górna
upper rail



nr 1141 KPZ-075
stoper zatrzaskowy
door stopper



nr 1120 MP-100
okucie budowlane STANDARD
hardware STANDARD



nr 1180 PBB-075
mocowanie boczne do płyt
side assembling for hardware





nr 6 C-10
ceownik
c-profile



nr 1150 AO-075 (biały | white)
nr 1151 AO-075 (brąz | brown)
przewodnik
guide



KOMPLET / SET zawiera 2 sztuki / box content

SYNCHRONIK		2 nr 1068	
 nr 1120	4	 nr 1110	1
 nr 1121	4	 nr 1111	1
 nr 1141	4	 nr 1140	1
 nr 1150	4	 nr 1151	2

KOMPLET OKUĆ SET	NR KPL SET NO.	WAGA WEIGHT	IŁOŚĆ KPL W KARTONIE NO. OF SETS IN BOX	WAGA KARTONU CARTON WEIGHT	UDŹWIG DO 100 KG CAPACITY UP TO 100 KG
2 SKRZYDŁA 2 DOOR LEAVES	1068	1,12 kg	9 kpl / box	10.44 kg	tylko 2 skrzydła 2 door leaves only  



ŁOŻYSKO KULKOWE
BALL BEARING

min 60 cm / max 100 cm
szerokość drzwi / door width



100kg

PLYTA | BOARD

18-40mm

mocowanie maskownicy aluminiowej
assembling of aluminium cover

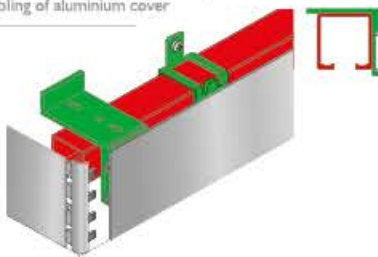

mocowanie maskownicy drewnianej
assembling of wooden cover

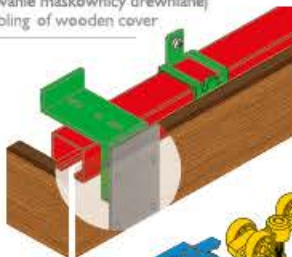

Szczegółowa instrukcja montażu
Detailed assembly manual
www.laguna.pl

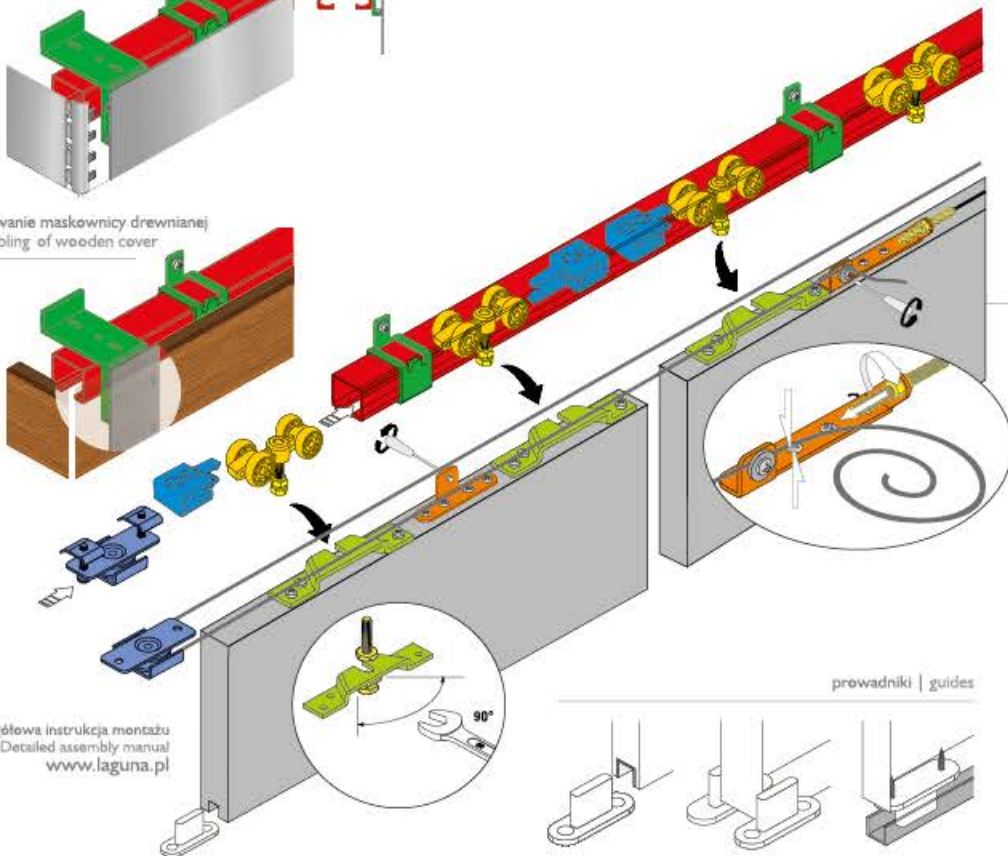

uchwyty | fastenings

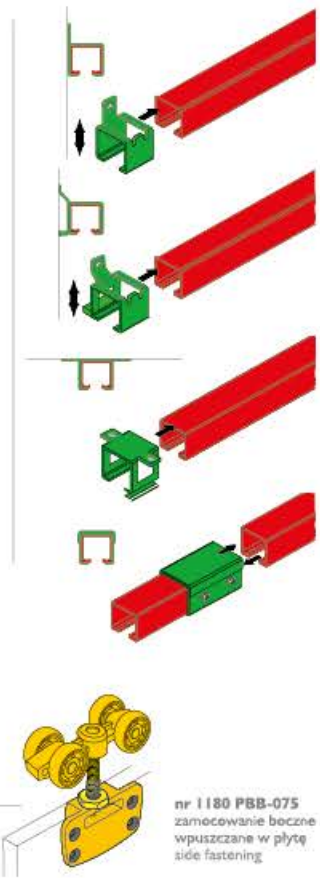

nr 1180 PBB-075
zamocowanie boczne
wpuszczane w płytę
side fastening

przewodniki | guides

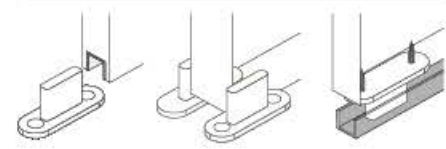

SZYNY I PROFILE
RAILS AND PROFILES

aluminium długość max 6m
length max 6m



nr 1 K-075
szyna górna
upper rail

aluminium długość max 6m
length max 6m



nr 1190
maskownica anodowana
anodized cover rail

stal | steel długość max 4m
length max 4m



nr 13 K-076
szyna górna
upper rail

aluminium długość max 6m
length max 6m



nr 6 C-10
ceownik
c-profile

KOMPLET NA 2 SKRZYDŁA 2 DOOR LEAVES



x4

nr 1120 MP-100
okucie budowlane STANDARD
hardware STANDARD



x4

nr 1121 PB-075
zamocowanie do płyty
fastening to board



x24

wkręty
screws



x4

nr 1141 KPZ-075
stoper zatrzaskowy
door stopper

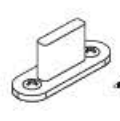

x4

nr 1150 AO-075
przewodnik biały
white guide

nr 681 komplet mocowania linki SYNCHRONIK / GUSTAVSON - rope nr. SYNCHRONIK / GUSTAVSON



x1

mocowanie SYNCHRONIK
SYNCHRONIK rope



x1

kątownik SYNCHRONIK
SYNCHRONIK angle



x2

naciąg linki SYNCHRONIK
SYNCHRONIK rope tension



x1

linka 8mb
rope 8m

ELEMENTY MASKOWNICY

cover rail corner and holders

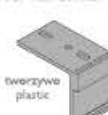

tworzywo
plastic



tworzywo
plastic

nr 1191
uchwyt sufitowy
fastening for ceiling

nr 1192
uchwyt ścienny
fastening for wall



tworzywo
plastic

nr 1193 RT8
narożnik z tworzywa
plastic corner



aluminium

nr 1194
mocowanie maskownicy
drewnianej
wooden cover fastening

UCHWYTY DO SZYNY K075/76 K075/76 RAIL FITTINGS

montaż co 30cm | 30cm mounting distances



nr 1131 SKU-075
uchwyt do ściany
rail holder (to wall)



nr 1132 KK-075
uchwyt do sufitu
rail holder (to ceiling)



nr 1134 SKL-075
uchwyt z dystansem do ściany
wall fastening with distance



nr 1133 LKU-075
łącznik szyn
rails connector

ELEMENTY OPCJONALNE

OPTIONAL ELEMENTS



nr 1180 PBB-075
zamocowanie boczne
wpuszczane w płytę
side fastening

ELEMENTY ZAMIENNI

INTERCHANGEABLE
ELEMENTS



nr 1151 AO-075
przewodnik brązowy
brown guide



nr 1190
maskownica anodowana
anodized cover rail



nr 1134 SKL-075
uchwyt z dystansem do ściany
wall fastening with distance



nr 1 K-075
szyna górna
upper rail



nr 1141 KPZ-075
stoper zatrząskowy
door stopper



nr 1680
samodomykacz STANDARD
soft closing STANDARD



nr 1175 MPG-100
8mm / 10mm / 12mm
okucie PORTA GLASS
hardware PORTA GLASS



nr 1101 AO-G
prowadnik PORTA GLASS
lower guide PORTA GLASS



KOMPLET OKUĆ SET	NR KPL SET NO.	WAGA WEIGHT	ILOŚĆ KPL W KARTONIE NO. OF SETS IN BOX	WAGA KARTONU CARTON WEIGHT	UDŹWIG DO 75 KG CAPACITY UP TO 75 KG
1 SKRZYDŁO 1 DOOR LEAF	8mm	1,30 kg	9 kpl / box	12,10 kg	1 
	10mm	1,33 kg	9 kpl / box	12,37 kg	
	12mm	1,36 kg	9 kpl / box	12,62 kg	

KOMPLET / SET - zawartość pudełka / box content		
PORTA GLASS	8mm nr 1202 10mm nr 1200 12mm nr 1201	1 
	nr 1175	2
	nr 1141	2
	nr 1101	1

mocowanie maskownicy aluminiowej
assembling of aluminium cover

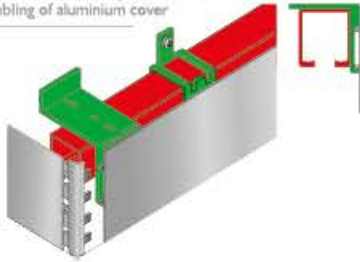

mocowanie maskownicy drewnianej
assembling of wooden cover

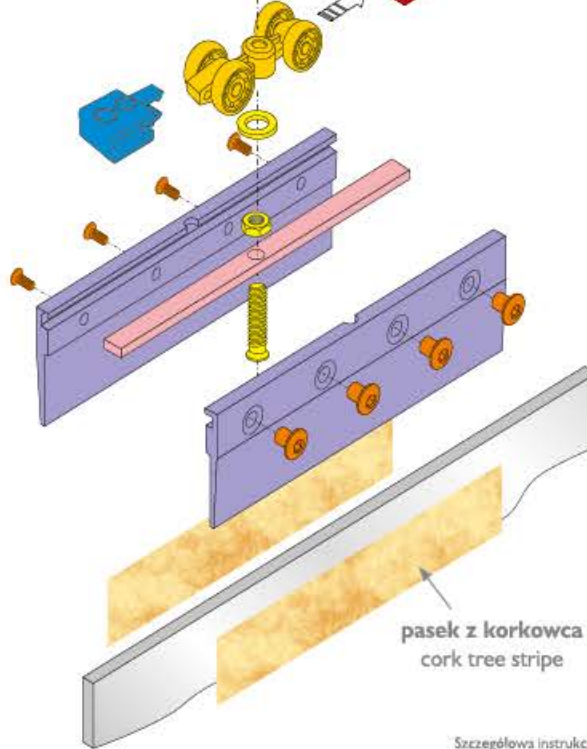
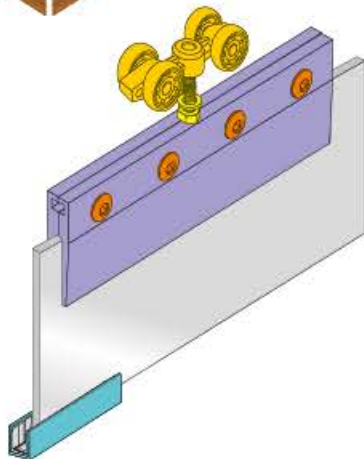
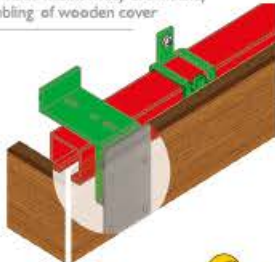

pasek z korkowca
cork tree stripe

Szczegółowa instrukcja montażu
Detailed assembly manual
www.laguna.pl

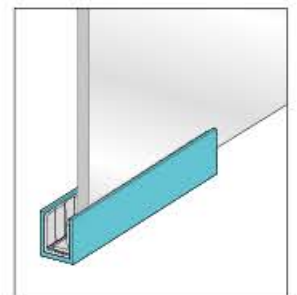
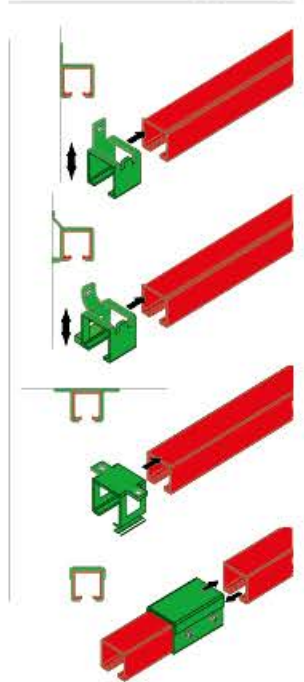

SZYNY I PROFILE
RAILS AND PROFILES

aluminium

dlugość max 6m
length max 6m



nr 1 K-075
szyna górna
upper rail

stal | steel

dlugość max 4m
length max 4m



nr 13 K-076
szyna górna
upper rail

aluminium

dlugość max 6m
length max 6m



nr 1190
maskownica anodowana
anodized cover rail

KOMPLET NA 1 SKRZYDŁO | DOOR LEAF SET

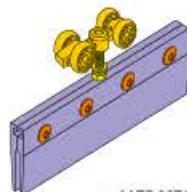

x2

nr 1175 MPG-100
8mm / 10mm / 12mm
okucie PORTA GLASS
hardware PORTA GLASS



x2

nr 1141 KPZ-075
stoper zatraskowy
door stopper

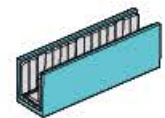

x1

nr 1101 AO-G
przewodnik PORTA GLASS
lower guide PORTA GLASS

ELEMENTY MASKOWNICY

cover rail corner and holders



tworzywo
plastic

nr 1191
uchwyt sufitowy
fastening for ceiling



tworzywo
plastic

nr 1192
uchwyt naścienny
fastening for wall



tworzywo
plastic

nr 1193 RTS
narożnik z tworzywa
plastic corner

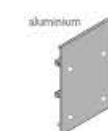

aluminium

nr 1194
mocowanie maskownicy
drewnianej
wooden cover fastening

UCHWYTY DO SZYNY K075/76 K075/76 RAIL FITTINGS

montaż co 30cm | 30cm mounting distances



nr 1131 SKU-075
uchwyt do ściany
rail holder (to wall)



nr 1132 KK-075
uchwyt do sufitu
rail holder (to ceiling)



nr 1134 SKL-075
uchwyt z dystansem do ściany
wall fastening with distance



nr 1133 LKU-075
łącznik szyn
rails connector

SAMODOMYKACZ SOFTCLOSER



nr 1680
samodomykacz STANDARD
soft closing STANDARD
50kg

ELEMENTY ZAMIENNI

INTERCHANGEABLE
ELEMENTS



nr 1102 AO-P
przewodnik przezroczysty
transparent lower guide



nr 1190
maskownica anodowana
anodized cover rail



nr 1134 SKL-075
uchwyt z dystansem do ściany
wall fastening with distance



nr 1 K-075
szyna górna
upper rail



nr 1141 KPZ-075
stoper zatrzaskowy
door stopper



nr 1680
samodomykacz STANDARD
soft closing STANDARD



nr 1175 MPG-100
8mm / 10mm / 12mm
okucie PORTA GLASS
hardware PORTA GLASS



nr 1101 AO-G
przewodnik PORTA GLASS
lower guide PORTA GLASS



KOMPLET OKUCI SET	NR. KPL SET NO.	WAGA WEIGHT	ILOŚĆ KPL W KARTONIE NO. OF SETS IN BOX	WAGA KARTONU CARTON WEIGHT	UDZWIIG DO 75 KG CAPACITY UP TO 75 KG
2 SKRZYDŁA 2 DOOR LEAVES	8mm	1212	4 kpl / box	11,48 kg	tylko 2 skrzydła 2 door leaves only
	10mm	1210	4 kpl / box	11,60 kg	
	12mm	1211	4 kpl / box	11,84 kg	

KOMPLET / SET zawiera: / zestaw zawiera: / box content

PORTA GLASS SYNCHRONIK	8mm nr 1212	10mm nr 1210	12mm nr 1211	2
nr 1175	4	nr 1203	1	
nr 1141	3	nr 1203	1	
nr 1680	1	nr 1203	1	
nr 1101	2	nr 1203	2	



mocowanie maskownicy aluminiowej
assembling of aluminium cover

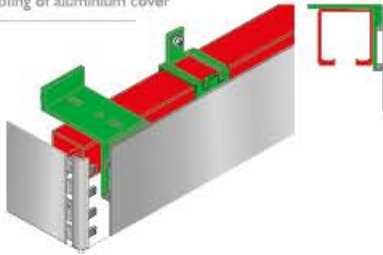

mocowanie maskownicy drewnianej
assembling of wooden cover

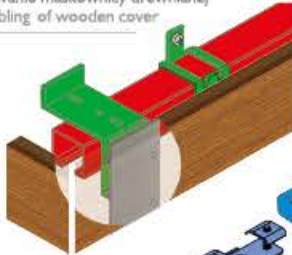

uchwyty | fastenings

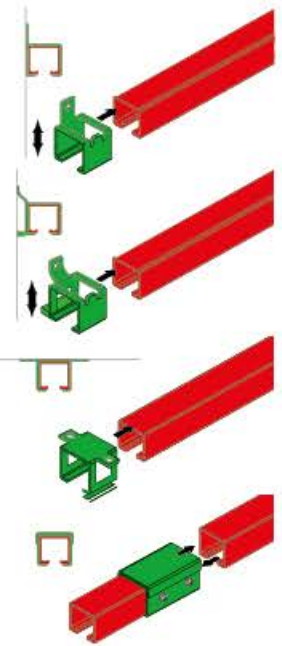

Szczegółowa instrukcja montażu
Detailed assembly manual
www.laguna.pl

pasek z korkowca
cork tree stripe

SZYNY I PROFILE
RAILS AND PROFILES

aluminium długość max 6m
length max 6m



nr 1 K-075
szyna górna
upper rail

aluminium długość max 6m
length max 6m



nr 1190
maskownica anodowana
anodized cover rail

stal | steel długość max 4m
length max 4m



nr 13 K-076
szyna górna
upper rail

KOMPLET NA 2 SKRZYDŁA 2 DOOR LEAVES

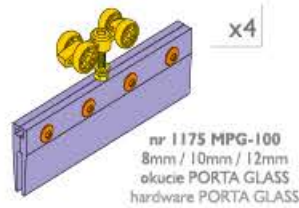

nr 1203 komplet mocowania linki PORTA GLASS - SYNCHRONIK rope set PORTA GLASS - SYNCHRONIK



ELEMENTY MASKOWNICY
cover rail corner and holders



UCHWYTY DO SZYNY K075/76 K075/76 RAIL FITTINGS

montaż co 30cm | 30cm mounting distances



ELEMENTY ZAMIENNIE INTERCHANGEABLE ELEMENTS





nr 9 K-015
szyna górna BIFOLD
upper rail BIFOLD



nr 905
gniazdo górne BIFOLD
upper seat BIFOLD



nr 901
czop górny BIFOLD
upper pin BIFOLD



nr 903
przewodnik górny BIFOLD
upper guide BIFOLD



nr 900
amortyzator BIFOLD
shock absorber BIFOLD



nr 1143 HI-276 chrom / chrome
nr 1142 HI-276 mosiądz / brass
zawias
hinge



nr 902
czop dolny BIFOLD
lower pin BIFOLD



nr 906
gniazdo dolne BIFOLD
lower seat BIFOLD



KOMPLET / SET : zawartość pudełka / box content

KOMPLET OKUĆ SET	NR KPL SET NO.	WAGA WEIGHT	IŁOŚĆ KPL W KARTONIE NO. OF SETS IN BOX	WAGA KARTONU CARTON WEIGHT	UDŹWIG DO 15 KG CAPACITY UP TO 15 KG
2 SKRZYDŁA 2 DOOR LEAFS	9990 mosiądz brass	0,240 kg	48 kpl / box	11,52 kg	2
	9993 chrom chrome	0,240 kg	48 kpl / box	11,52 kg	
	9995 LUX LUX	0,370 kg	48 kpl / box	17,76 kg	
4 SKRZYDŁA 4 DOOR LEAFS	9991 mosiądz brass	0,480 kg	48 kpl / box	23,04 kg	4
	9994 chrom chrome	0,480 kg	48 kpl / box	23,04 kg	
	9996 LUX LUX	0,740 kg	48 kpl / box	35,52 kg	

BIFOLD	2 nr 9990 nr 9993 nr 9995	4 nr 9991 nr 9994 nr 9996
nr 903		2
nr 901		2
nr 902		2
nr 905		2
nr 900		2
nr 906		2
nr 1142 nr 1143 nr 1177	3	6
nr 906	×	2



TWORZYWO
PLASTIC



15kg



16-40mm

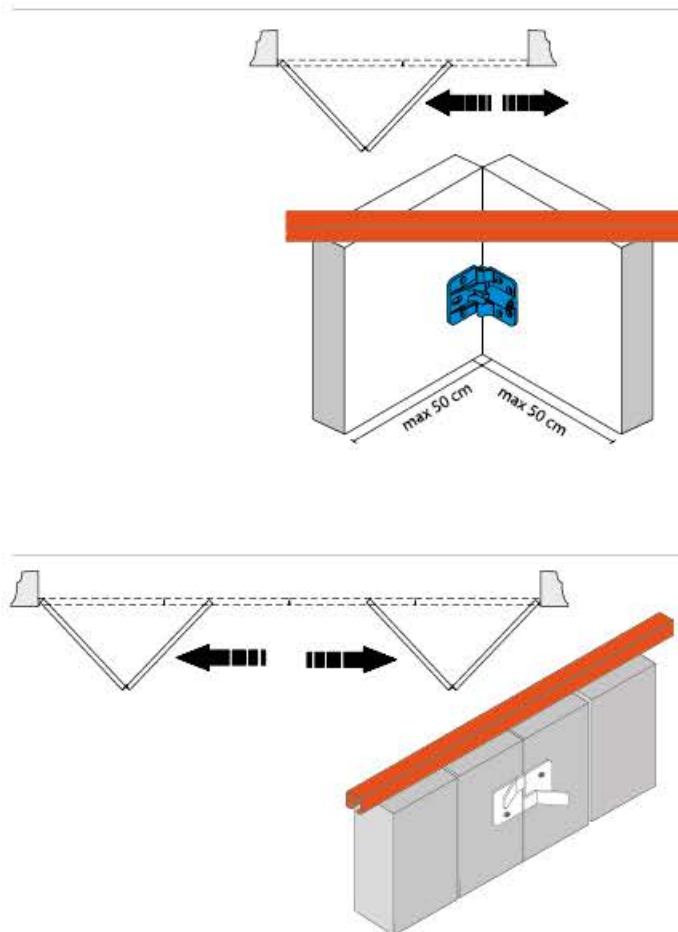
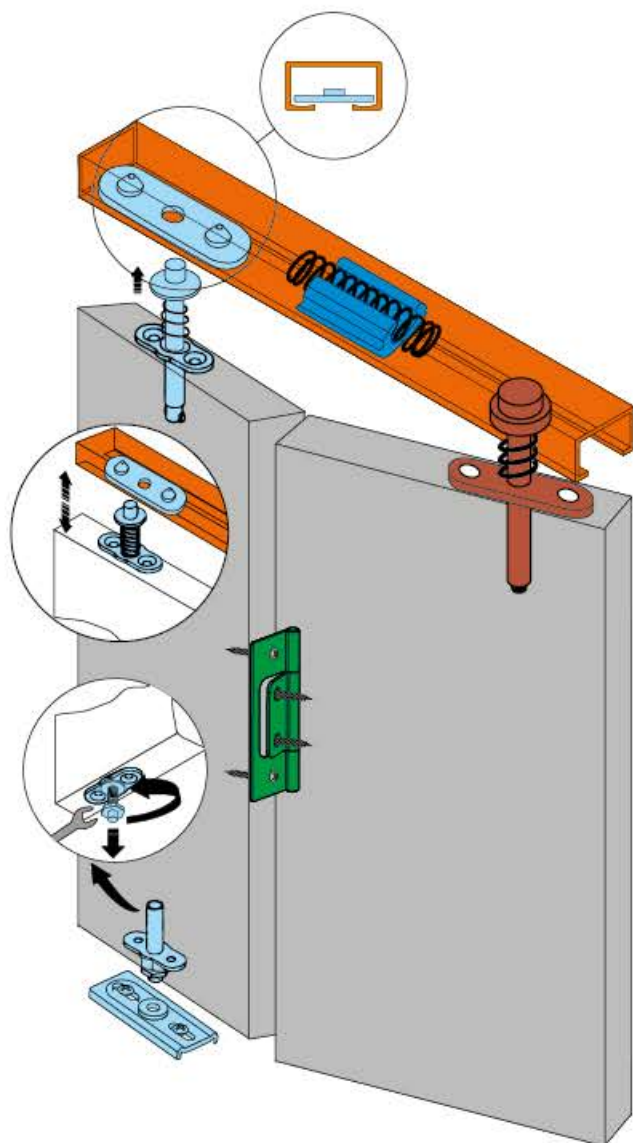

Szczegółowa instrukcja montażu
Detailed assembly manual
www.laguna.pl

blokada ustawcza
do 2 skrzydeł
position interlock
for 2 door leaves

SZYNY I PROFILE
RAILS AND PROFILES

aluminium

dlugość max 6m
length max 6m

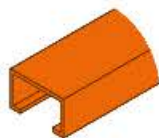

nr 9 K-015
szyna górna BIFOLD
upper rail BIFOLD

ELEMENTY OPCJONALNE
OPTIONAL ELEMENTS

OPTIONAL ELEMENTS

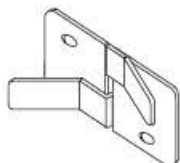

nr 1174
blokada ustawcza
position interlock

KOMPLET NA 1 SKRZYDŁO | DOOR LEAF SET



x1
nr 903
przewodnik górny BIFOLD
upper guide BIFOLD



x1
nr 901
czop górny BIFOLD
upper pin BIFOLD



x1
nr 902
czop dolny BIFOLD
lower pin BIFOLD

x20



komplet wkrętów
screws set



x1
nr 905
gniazdo górne BIFOLD
upper seat BIFOLD



x1
nr 900
amortyzator BIFOLD
shock absorber BIFOLD

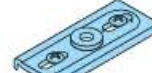

x1
nr 906
gniazdo dolne BIFOLD
lower seat BIFOLD

ZAWIASY W KOMPLETACH, DOBIERANE ZAMIENNIE | INTERCHANGEABLE HINGES IN SET



x3
nr 1177
zawias LUX
LUX hinge



kolor srebrny
color silver



x3
nr 1143 HI-276
zawias chrom
hinge chrome



kolor chrom
color chrome



x3
nr 1142 HI-276
zawias mosiądz
hinge brass



kolor mosiądz
color brass



nr 1 K-075
szyna górna aluminiowa
aluminium upper rail



nr 1132 KK-075
uchwyt do sufitu
rail holder (to ceiling)



nr 909
gniazdo górne STANFOLD
upper seat STANFOLD



nr 1112 PGP-075
okucie budowlane EKOFOLD
z mocowaniem PBP-M6
hardware EKOFOLD
with fastening PBP-M6



nr 1140 KP-075
stoper / odbojnik
door stopper



nr 901
czop górny BIFOLD
upper pin BIFOLD



nr 1143 HI-276 chrom / chrome
nr 1142 HI-276 mosiądz / brass
zawias
hinge



nr 902
czop dolny BIFOLD
lower pin BIFOLD



nr 906
gniazdo dolne BIFOLD
lower seat BIFOLD



KOMPLET OKUĆ SET	NR KPL. SET NO.	WAGA WEIGHT	ILOŚĆ KPL W KARTONIE NO. OF SETS IN BOX	WAGA KARTONU CARTON WEIGHT	UDŹWIG DO 20 KG CAPACITY UP TO 20 KG
2 SKRZYDŁA 2 DOOR LEAFS	1164 mosiądz brass 1166 chrom chrome 1170 LUX LUX	0,300 kg 0,300 kg 0,480 kg	48 kpl / box 48 kpl / box 48 kpl / box	14,40 kg 14,40 kg 23,04 kg	2
4 SKRZYDŁA 4 DOOR LEAFS	1165 mosiądz brass 1167 chrom chrome 1171 LUX LUX	0,630 kg 0,630 kg 0,730 kg	48 kpl / box 48 kpl / box 48 kpl / box	30,24 kg 30,24 kg 35,24 kg	4

KOMPLET / SET zawiera: pudełko / box contain			
EKOFOLD	2	4	
nr 1179	1	2	
nr 909	1	2	
nr 901	1	2	
nr 902	1	2	
nr 906	1	2	
nr 1142 nr 1143 nr 1177	3	6	
nr 906	×	2	



ŁOŻYSKO KULKOWE
BALL BEARING



szerokość drzwi / door width



20kg



PLYTA | BOARD

18-40mm

uchwyt | fastening

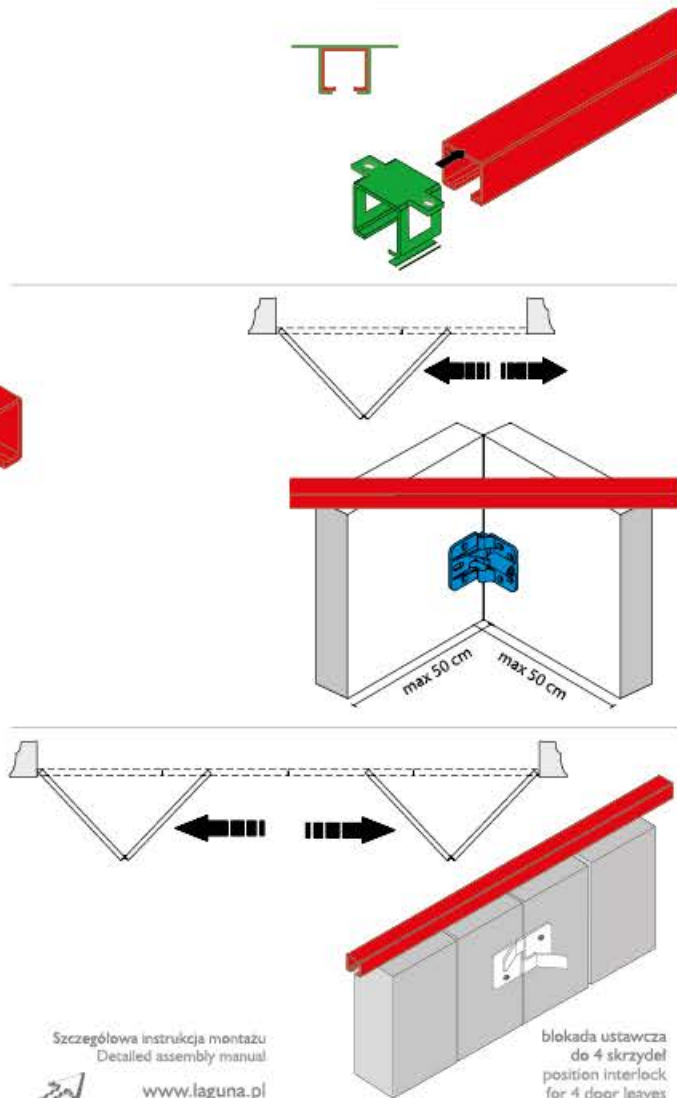
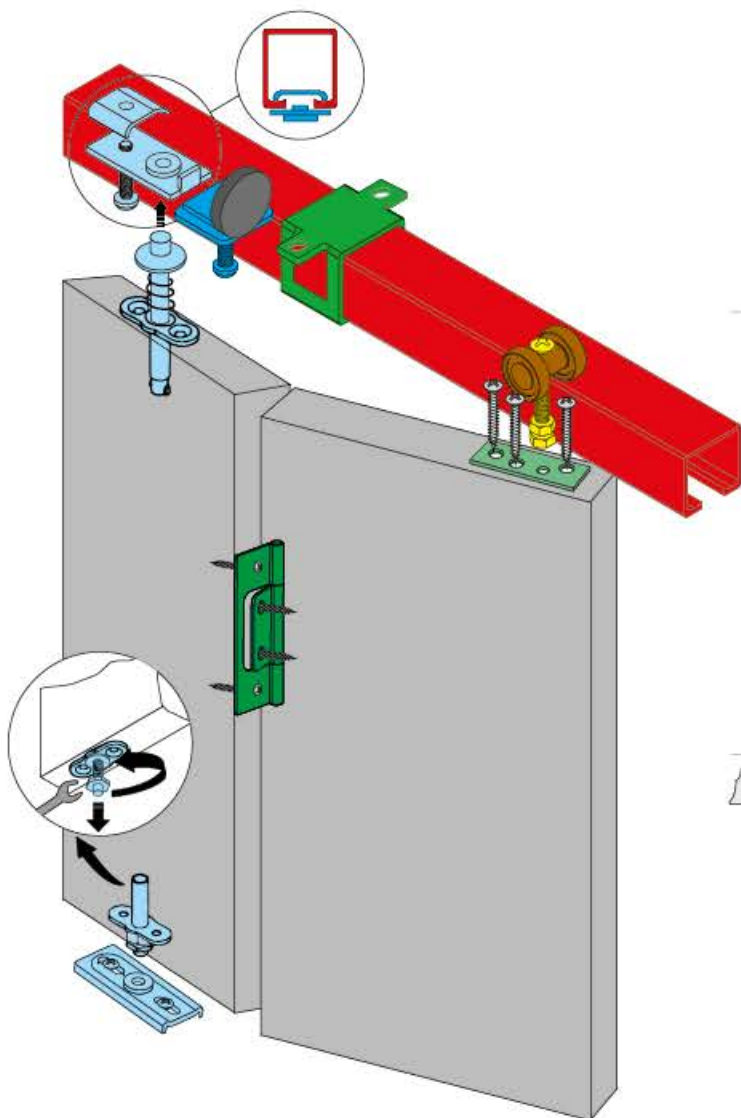

Szczegółowa instrukcja montażu
Detailed assembly manual



www.laguna.pl

blokada ustawcza
do 4 skrzydeł
position interlock
for 4 door leaves

SZYNY I PROFILE

RAILS AND PROFILES

aluminium

dlugość max 6m
length max 6m



nr 1 K-075
szyna górna
upper rail

stal | steel

dlugość max 4m
length max 4m



nr 13 K-076
szyna górna
upper rail

KOMPLET NA 1 SKRZYDŁO | DOOR LEAF SET



x1

nr 909
gniazdo górne STANFOLD
upper seat STANFOLD



x1

nr 901
czop górny BIFOLD
upper pin BIFOLD



x1

nr 902
czop dolny BIFOLD
lower pin BIFOLD



x1



x1

nr 906
gniazdo dolne BIFOLD
lower seat BIFOLD



komplet wkrętów
screws set

x21

ELEMENTY OPCJONALNE

OPTIONAL ELEMENTS



nr 1140 KP-075
stoper / odbojnik
door stopper

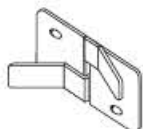

nr 1174
blokada ustawcza
position interlock

UCHWYTY DO SZYNY

RAIL FITTINGS



nr 1132 KK-075
uchwyt do sufitu
rail holder (to ceiling)

ZAWIASY W KOMPLETACH, DOBIERANE ZAMIENNIE INTERCHANGEABLE HINGES IN SET



x3

nr 1177
zawias LUX
LUX hinge

kolor srebrny
color silver



x3

nr 1143 HI-276
zawias chrom
hinge chrome

kolor chrom
color chrome



x3

nr 1142 HI-276
zawias mosiądz
hinge brass

kolor mosiądz
color brass



nr 1 K-075
szyna górna
upper rail



nr 1132 KK-075
uchwyt do sufitu
rail holder (to ceiling)



nr 909
gniazdo górne STANFOLD
upper seat STANFOLD



nr 1179 MPF-075
okucie budowlane STANFOLD
z mocowaniem PBP-M8
hardware STANFOLD
with fastening PBP-M8



nr 1141 KPZ-075
stoper zatrzaskowy
door stopper



nr 901
czop górny BIFOLD
upper pin BIFOLD



nr 1143 HI-276 chrom / chrome
nr 1142 HI-276 mosiądz / brass
zawias
hinge



nr 902
czop dolny BIFOLD
lower pin BIFOLD



nr 906
gniazdo dolne BIFOLD
lower seat BIFOLD



KOMPLET OKUC SET	NR KPL SET NO.	WAGA WEIGHT	ILOŚĆ KPL W KARTONIE NO. OF SETS IN BOX	WAGA KARTONU CARTON WEIGHT	UDŹWIG DO 40 KG CAPACITY UP TO 40 KG
2 SKRZYDŁA 2 DOOR LEAFS	1158 mosiądz brass 1156 chrom chrome 1168 LUX LUX	0,370 kg 0,370 kg 0,500 kg	48 kpl / box	17,76 kg 17,76 kg 24,00 kg	2
4 SKRZYDŁA 4 DOOR LEAFS	1159 mosiądz brass 1157 chrom chrome 1169 LUX LUX	0,770 kg 0,770 kg 1,080 kg	48 kpl / box	36,96 kg 36,96 kg 51,84 kg	4

KOMPLET / SET zawartość pudełka / box content			
STANFOLD	2	4	
nr 1179	1	2	
nr 909	1	2	
nr 901	1	2	
nr 902	1	2	
nr 906	1	2	
nr 1142 nr 1143	3	6	
nr 906	×	2	



ŁOŻYSKO KULKOWE
BALL BEARING

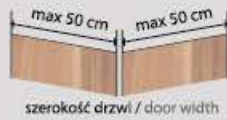

40kg



18-40mm

uchwyt | fastening

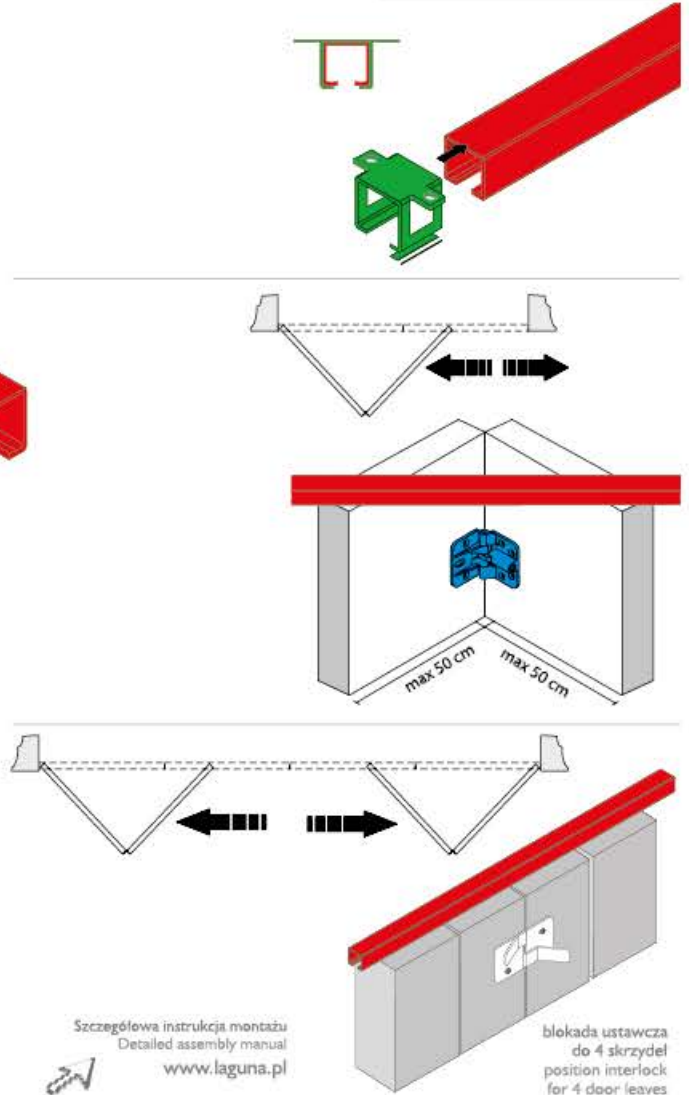
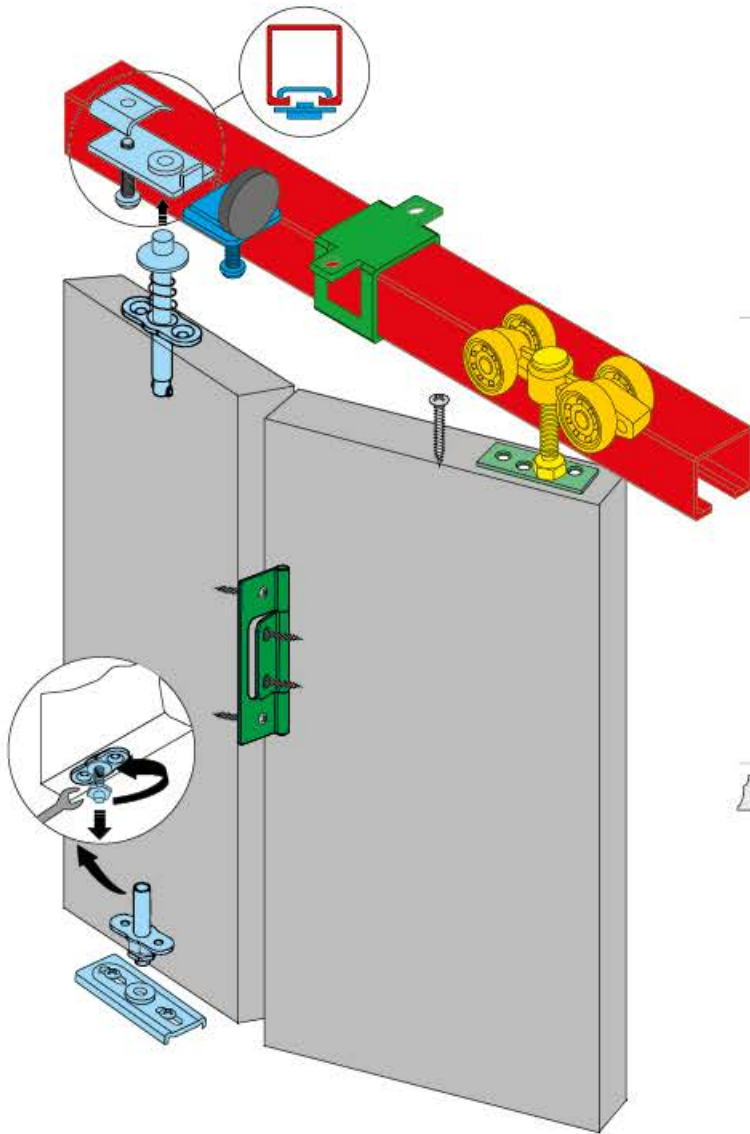

Szczegółowa instrukcja montażu
Detailed assembly manual
www.laguna.pl

SZYNY I PROFILE

RAILS AND PROFILES

aluminium długość max 6m
length max 6m



nr 1 K-075
szyna górna
upper rail

stal | steel długość max 4m
length max 4m



nr 13 K-076
szyna górna
upper rail

KOMPLET NA 1 SKRZYDŁO | DOOR LEAF SET

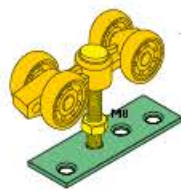

nr 1179 MPF-075
okucie budowlane STANFOLD
z mocowaniem PBP-M8
hardware STANFOLD
with fastening PBP-M8

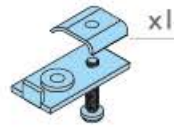

nr 909
gniazdo górne STANFOLD
upper seat STANFOLD



nr 901
czop górny BIFOLD
upper pin BIFOLD



nr 902
czop dolny BIFOLD
lower pin BIFOLD

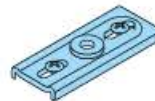

nr 906
gniazdo dolne BIFOLD
lower seat BIFOLD



komplet wkrętów
screws set

ELEMENTY OPCJONALNE

OPTIONAL ELEMENTS



nr 1140 KP-075
stoper / odbojnik
door stopper

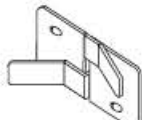

nr 1174
blokada ustawcza
position interlock

UCHWYTY DO SZYNY

RAIL FITTINGS



nr 1132 KK-075
uchwyt do sufitu
rail holder (to ceiling)

ZAWIASY W KOMPLETACH, DOBIERANE ZAMIENNIE | INTERCHANGEABLE HINGES IN SET



nr 1177
zawias LUX
hinge LUX



nr 1143 HI-276
zawias chrom
hinge chrome



nr 1142 HI-276
zawias miedź
hinge brass



nr 1190
maskownica anodowana
anodized cover rail



nr 1134 SKL-075
uchwyt z dystansem do ściany
wall fastening with distance



nr 1 K-075
szyna górna
upper rail



nr 1141 KPZ-075
stoper zatrzaskowy
door stopper



nr 1120 MP-100
okucie budowlane STANDARD
hardware STANDARD



nr 1121 PB-075
mocowanie do płyty
fastening to board



nr 82080
ramiak górny GAMA
upper profile GAMA



nr 82040
profil łączący GAMA
connecting profile GAMA



nr 82000 GAMA G-4/6/8/10
rączka
grip profile



nr 82080
ramiak górny GAMA
upper profile GAMA



nr 1154
prowadnik
guide



KOMPLET / SET zawiera / contains

SUSPEND 10	1	nr 1172
	2	
	2	
	2	
	2	
	1	

KOMPLET OKUC SET	NR KPL SET NO.	WAGA WEIGHT	ILOŚĆ KPL W KARTONIE NO. OF SETS IN BOX	WAGA KARTONU CARTON WEIGHT	UDŹWIG DO 40 KG CAPACITY UP TO 40 KG
1 SKRZYDŁO DOOR LEAF	1172	0,146 kg	9 szt	1,314 kg	1 

KOLORY COLORS	DOSTĘPNE KOLORY AVAILABLE COLORS		
			



ŁOŻYSKO KULKOWE
BALL BEARING



40kg

SZKŁO | GLASS

4, 6mm



PEŁTA | BOARD

8, 10mm

mocowanie maskownicy aluminiowej
assembling of aluminium cover

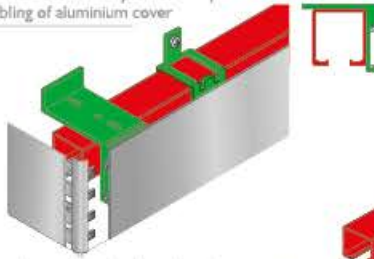

mocowanie maskownicy drewnianej
assembling of wooden cover

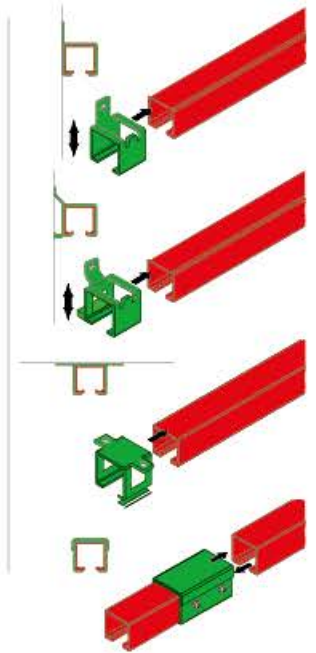
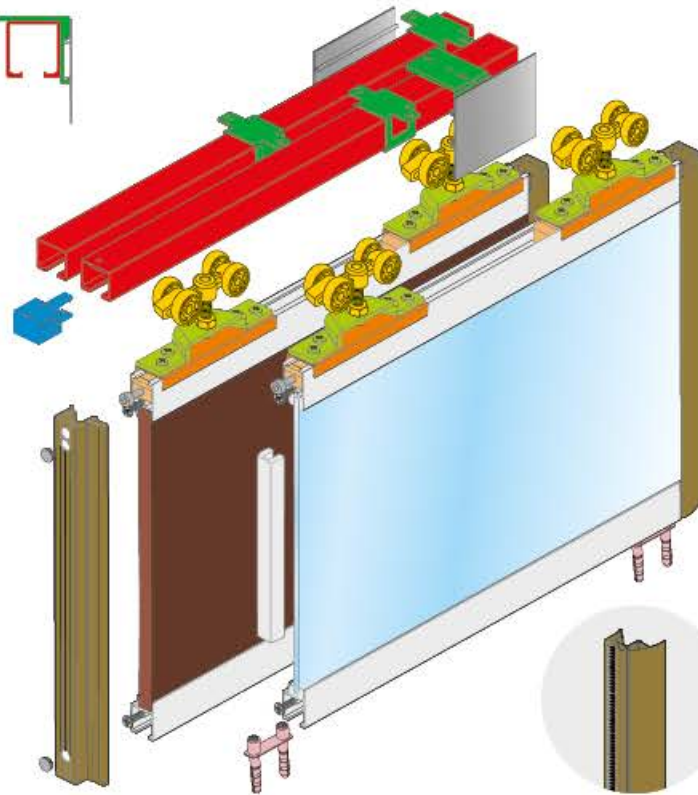
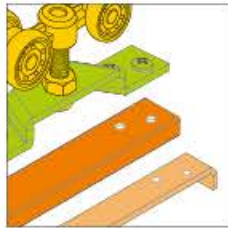
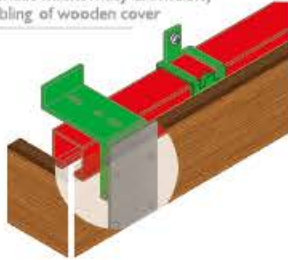

Szczegółowa instrukcja montażu
Detailed assembly manual
www.laguna.pl

SZYNY | PROFILE
RAILS AND PROFILES

aluminium	aluminium	stal steel	stal steel	aluminium	aluminium
dlugość max 6m length max 6m	dlugość max 6m length max 6m	dlugość max 4m length max 4m	dlugość max 4m length max 4m	dlugość max 6m length max 6m	dlugość max 6m length max 6m

KOMPLET NA 1 SKRZYDŁO | DOOR LEAF SET

ADAPTER 10mm nr 1182

x2	x2	x2	x8	x1
x2		x2		x2

ELEMENTY MASKOWNICY
cover rail corner and holders

ELEMENTY OPCJONALNE OPTIONAL ELEMENTS

--	--	--	--	--

UCHWYTY DO SZYNY K075/76 K075/76 RAIL FITTINGS

montaż co 30cm | 30cm mounting distances

--	--	--	--	--

ELEMENTY ZAMIENNE
INTERCHANGEABLE ELEMENTS

SUSPEND 18

ADAPTACJA SYSTEMU ZABUDOWY DO DRZWI PRZEJŚCIOWYCH
ADAPTATION OF HIGH FURNISHING SYSTEM FOR PASSAGE INTERIOR DOOR



nr 1190
maskownica anodowana
anodized cover rail



nr 1134 SKL-075
uchwyt z dystansem do ściany
wall fastening with distance



nr 1 K-075
szyna górna
upper rail



nr 1680
samodomykacz STANDARD
soft closing STANDARD



nr 1141 KPZ-075
stoper zatrzaskowy
door stopper



nr 1120 MP-100
okucie budowlane STANDARD
hardware STANDARD



nr 1121 PB-075
mocowanie do płyty
fastening to board



nr 8830
ramiak RAMA
profile RAMA



nr 1153
przewodnik
guide



KOMPLET OKUC SET	NR.KPL SET NO.	WAGA WEIGHT	ILOŚĆ KPL W KARTONIE NO. OF SETS IN BOX	WAGA KARTONU CARTON WEIGHT	UDŹWIG DO 50 KG CAPACITY UP TO 50 KG
SKRZYDŁO DOOR LEAF	1173	0,56 kg	50 szt	28,05 kg	1

KOLORY COLORS	DOSTĘPNE KOLORY AVAILABLE COLORS
	naturalny natural nr 000 (0)
	szampański champagne nr 000 (4)
	słoty gold nr 000 (5)
	czarny błękit nr 000 (6)

KOMPLET / SET zawiera 1000 podzłacz / box content

SUSPEND 18	1	nr 1173
	nr 1183	2
	nr 1120	2
	nr 1121	2
	nr 1141	2
	nr 1153	1



mocowanie maskownicy aluminiowej
assembling of aluminium cover

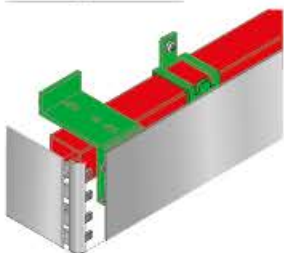

mocowanie maskownicy drewnianej
assembling of wooden cover

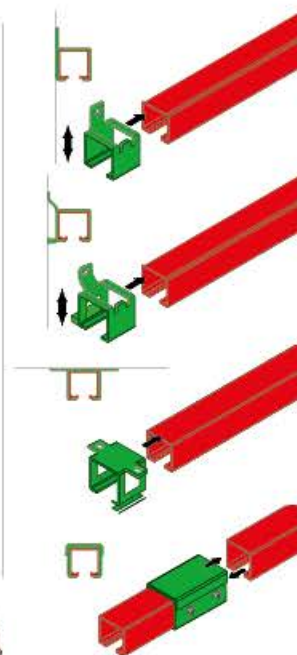
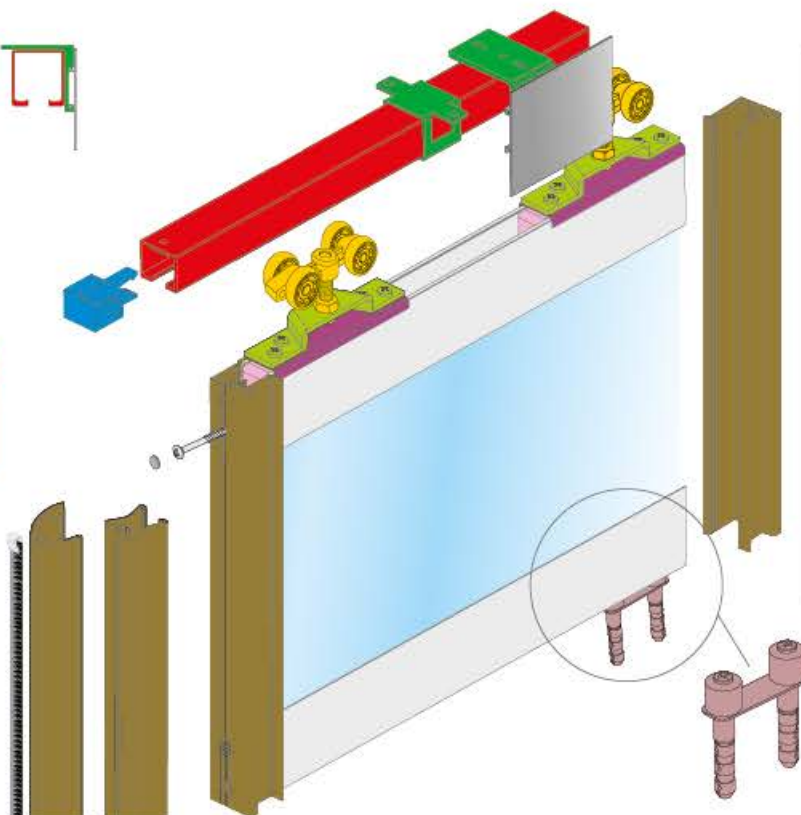
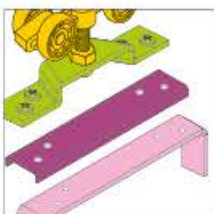
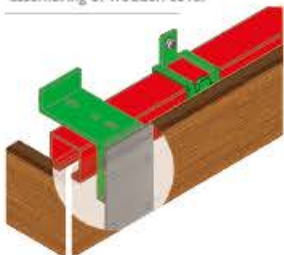









Szczegółowa instrukcja montażu
Detailed assembly manual
www.laguna.pl

SZYNY I PROFILE
RAILS AND PROFILES

<p>aluminium długość max 6m length max 6m</p>  <p>nr 1 K-075 szyna górna upper rail</p>	<p>stal steel długość max 4m length max 4m</p>  <p>nr 13 K-076 szyna górna upper rail</p>	<p>aluminium długość max 6m length max 6m</p>  <p>nr 1190 maskownica anodowana anodized cover rail</p>		
 <p>nr 8130 INTERO I-18 rączka grip profile</p>	 <p>nr 8770 MULTIOMEGA rączka grip profile</p>	 <p>nr 8170 MULTIOMEGA BRUSH rączka grip profile</p>	 <p>nr 8820 RAMA R-4/16/18 rączka grip profile</p>	 <p>nr 8140 RAMA BRUSH R-4/16/18 rączka grip profile</p>

KOMPLET NA 1 SKRZYDŁO | DOOR LEAF SET

ADAPTER 18mm nr 1183

x2	x2	x2	x8	x1
				
ceownik SUSPEND 18 c-profile SUSPEND 18	plaskownik SUSPEND 18 flat profile SUSPEND 18	wkręt screw	śruba imbusowa allen screw	nr 1153 prowadnik guide
x2	x2	x2		
				
nr 1120 MP-100 okucie budowlane STANDARD hardware STANDARD	nr 1121 PB-075 mocowanie do płyty fastening to board	nr 1141 KPZ-075 stoper zatrzaskowy door stopper		



nr 8830
ramiak RAMA
horizontal profile RAMA





nr 8870
profil łączący RAMA
connecting profile RAMA



nr 8180
łącznik DOMUS
connecting profile DOMUS

ELEMENTY MASKOWNICY

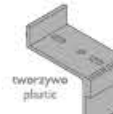
cover rail corner and holders





	
nr 1191 uchwyty sufitowy fastening for ceiling	nr 1192 uchwyty ścienny fastening for wall
	
nr 1193 RT8 narożnik z tworzywa plastic corner	nr 1194 mocowanie maskownicy drewnianej wooden cover fastening

ELEMENTY OPCJONALNE OPTIONAL ELEMENTS

			
nr 8194 klips do szczotki bush clip	nr 0088 / nr 0090 szczotka odbojowa anti-impact brush	nr 0089 / nr 0091 szczotka przeciwkurzowa anti-dust brush	nr 8176 klin do szkła MULTIOMEGA wedge for glass MULTIOMEGA

UCHWYTY DO SZYNY K075/76 K075/76 RAIL FITTINGS

montaż co 30cm | 30cm mounting distances

			
nr 1131 SKU-075 uchwyty do ściany rail holder (to wall)	nr 1132 KK-075 uchwyty do sufitu rail holder (to ceiling)	nr 1134 SKL-075 uchwyty z dystansem do ściany wall fastening with distance	nr 1133 LKU-075 łącznik szyn rails connector



nr 683 / 684
kasety Gustavson
cassette Gustavson



nr 1120 MP-100
okucie budowlane STANDARD
hardware STANDARD



nr 1141 KPZ-075
stoper zatraskowy
door stopper



nr 1121 PB-075
mocowanie do płyty
fastening to board



nr 6 C-10
ceownik
c-profile



nr 1150 AO-075 (biały | white)
nr 1151 AO-075 (brąz | brown)
przewodnik
guide



KASETA ZESTAW CASSETTE KIT		NR KPL SET NO.	WAGA WEIGHT	GRUBOŚĆ ŚCIANY WALL THICKNESS	GRUBOŚĆ DRZWI DOOR THICKNESS	UDŹWIG DO 100 KG CAPACITY UP TO 100 KG
1 SKRZYDŁO 1 DOOR LEAF	KASETA 100	683	13,150 kg	100 mm	max 40 mm	1
	KASETA 125	684	13,500 kg	125 mm	max 50 mm	

FUTRYNA ZESTAW DOOR FRAME KIT		NR KPL SET NR	WAGA WEIGHT	GRUBOŚĆ ŚCIANY WALL THICKNESS	
1 SKRZYDŁO 1 DOOR LEAF	BIAŁA WHITE	100	687	6,580 kg	100
		125	688	6,750 kg	125
	BUKOWA BEECH	100	690	6,580 kg	100
		125	691	6,750 kg	125
2 SKRZYDŁA 2 DOOR LEAVES	BIAŁA WHITE	100	695	8,080 kg	100
		125	697	8,250 kg	125
	BUKOWA BEECH	100	696	8,080 kg	100
		125	698	8,080 kg	125



ŁOŻYSKO KULKOWE
BALL BEARING

min 60 cm / max 100 cm
szerokość drzwi / door width



PLYTA | BOARD

100kg
18-40mm



SZKŁO | GLASS

75kg
8mm / 10mm / 12mm

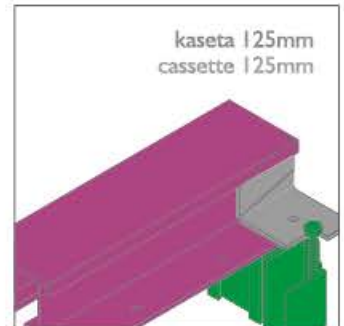
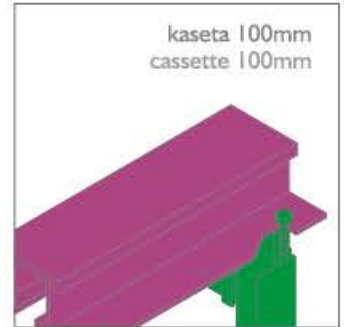
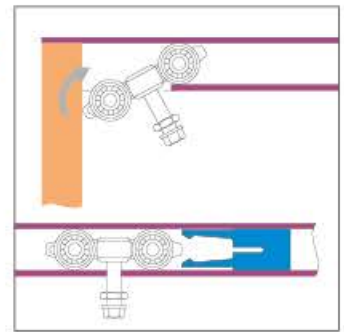
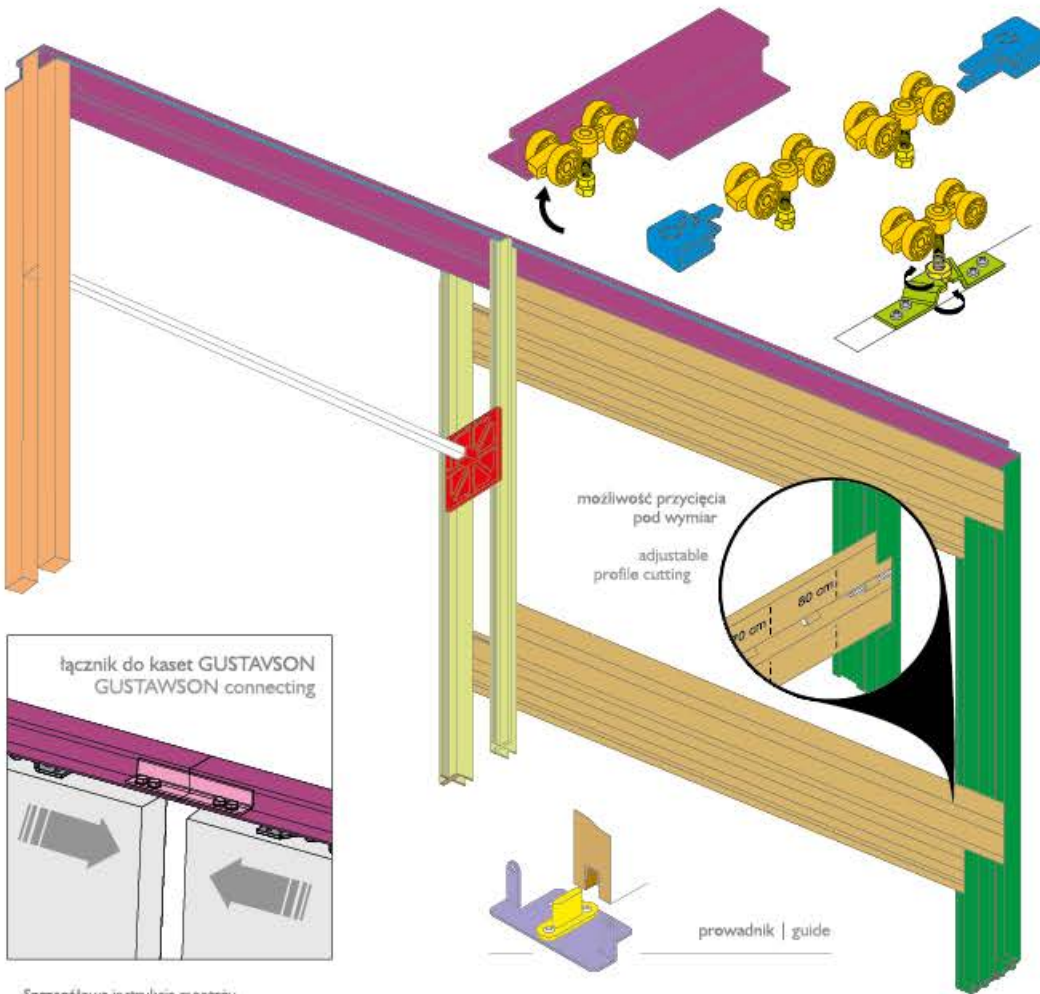

Szczegółowa instrukcja montażu
Detailed assembly manual
www.laguna.pl

KOMPLET GUSTAVSON GUSTAVSON KIT

- | | | | | |
|--|--|--|--|--|
| | | | | |
| | | | | |
| | | | | |

nr 681 komplet mocowania linki SYNCHRONIK / GUSTAVSON rope set SYNCHRONIK / GUSTAVSON

- | | | | |
|--|--|--|--|
| | | | |
|--|--|--|--|

ELEMENTY OPCJONALNE

OPTIONAL ELEMENTS

- SZKŁO GLASS**
- -
 -

ELEMENTY ZAMIENNE

- INTERCHANGEABLE ELEMENTS
-